

Drilled Wells

Peter Ball

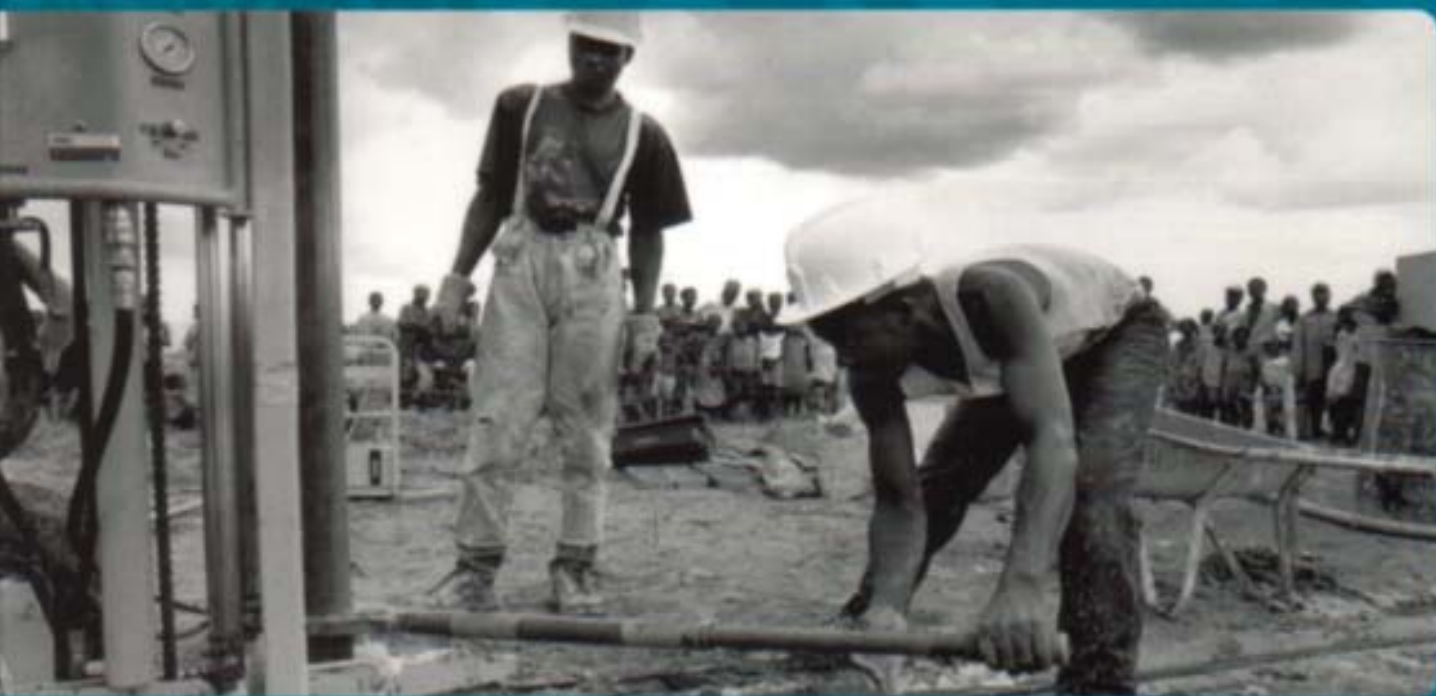

First edition: 2001, 1000 copies

Author: Peter Ball

Illustrations: Matthew Holmes

Published by: SKAT, Swiss Centre for Development Cooperation
in Technology and Management

Copyright: © SKAT, 2001

Comments: Please send any comments concerning this publication to:
SKAT
Vadianstrasse 42
CH-9000 St.Gallen, Switzerland
Tel: +41 71 228 54 54
Fax: +41 71 228 54 55
e-mail: info@skat.ch

Photos: Peter Ball
Cover photo: Crispin Hughes / Oxfam

Printed by: Niedermann Druck, St.Gallen, Switzerland

ISBN: 3-908001-98-6

Context

Access to adequate water, sanitation, drainage and solid waste disposal are four inter-related basic needs which impact significantly on socio-economic development and quality of life. The number of people around the world who still do not have access to these basic facilities, despite enormous global effort over more than two decades, provides sufficient evidence that conventional approaches and solutions alone are unable to make a sufficient dent in the service backlog which still exists. Numerous initiatives are ongoing at different levels to improve strategies, technologies, institutional arrangements, socio-cultural anchorage, and cost effectiveness, all to enhance efficiency and, eventually, to have an impact on the sector's goals. In addition, the ever-increasing scarcity of water brings policymakers together to find solutions to the challenge of water resource management. This series of manuals is intended as a contribution to these efforts.

Background

The decision to produce this series of manual was prompted by the positive experience gained with a practical manual based on the experience of Helvetas (a Swiss NGO) during the 1970s in Cameroon, which has become outdated with the passage of time. SDC (the Swiss Agency for Development and Co-operation) supported SKAT's initiative to produce this series, working with professionals with longstanding practical experience in the implementation of rural water supply projects. Lessons learnt during the workshops held by AGUASAN (an interdisciplinary working group of water and sanitation professionals from Swiss development and research organisations) over the last 14 years have been included where appropriate. In particular, there is an emphasis on documenting and illustrating practical experiences from all regions of the world.

The Manuals

As can be seen from the table on the back cover, this series of manuals is primarily aimed at project managers, engineers and technicians. However, given the wide range of subjects covered, it is also an important working tool for all actors in the sector, ranging from those involved with policy development to those constructing systems at village level. The series has a clear focus on water supply in rural settings. It proposes technologies with due consideration for socio-cultural, economic, institutional and regulatory requirements. This approach is in keeping with the SDC water and sanitation policy, emphasising the balanced development approach leading to sustainable programmes and projects.

It should be noted that the present series deals almost exclusively with water supply. The importance of sanitation is however clearly established in Volume 1, which deals predominantly with the software aspects necessary to achieve an impact. It includes some proposals for optional tools, approaches and institutional arrangements and is intended as an overall introduction to the other, more technical, volumes of the series.

Some final comments

The water and sanitation sector is constantly evolving. We would welcome any queries, comments or suggestions you might have. Your feedback will be made available to other interested users of the manuals.

Finally, we hope that these manuals will be useful for the practitioner in the field as well as for the planner in the office. If the series can be a contribution to providing water to more people in need on a sustainable basis, we will have achieved our goal.

The production of this series has only been possible through the continuous support of colleagues from all over the world. Our sincere thanks to all of them.

Armon Hartmann
Head of Water & Infrastructure Division
Swiss Agency for Development Co-operation

Karl Wehrle
Head of Water & Construction Division
SKAT

It is hoped that the following text will be found to be a practical text of use to those that drill holes in the ground for water, the people who are engaged in efforts to provide clean water to the poorest corners of the world.

The text is based on my experiences of travelling to various corners of the world working with various bits of equipment and people to drill holes in the ground. I also have the opportunity of standing up in front of questioning postgraduate students finding myself trying to explain the 'methodology of drilling'. Simply this book would not have been possible without those opportunities and experiences, acknowledgment is made to some of those organisations that made it possible.

- Oxfam GB
- Concern Universal
- Cranfield Institute of Technology
- RedR
- Tear Fund
- Concern Worldwide
- WEDC – at Loughborough University
- Southampton University

Many thanks to Jacqui Morris whose editorial skills changed the rambling prose of a 'driller' into the resemblance of good English.

Contents

Introduction	1
1. Drilling machines – The essential ingredients	3
1.1 Rotation.....	3
1.2 Torque & drill bits	3
1.3 Hard Rock drilling	3
1.4 Ground types	3
1.5 Drill pipe hoist	4
1.6 Avoiding bent holes.....	4
1.7 Lightweight rotary rigs	4
2. Drilling with fluids	7
2.1 Adequate pump flow for diameter of well being drilled	7
2.2 Fluid circulating pumps: ‘mud pumps’	8
2.3 Flow and friction	8
2.4 Preventing hole collapse – ‘hydrostatic head’	9
2.5 Hole Cleaning	10
2.6 Adequate settling pits	11
2.7 Drill fluid additives	13
2.7.1 Bentonite	13
2.7.2 Polymers	13
2.8 Viscosity measurement	13
2.8.1 Mixing volumes.....	14
2.8.2 Correct viscosity	14
2.9 Tips on the use of polymers	14
2.10 Ability to biodegrade.....	14
2.11 Dispersing	15
2.11.1 Chlorine	15
2.12 Lost circulation /fluid losses	15
2.13 Remedies.....	15
2.13.1 ‘Pills’	15
2.13.2 Fibre	15
2.13.3 Liquid Cement	16
2.14 Drilling Clay.....	16
2.15 Collaring	16
2.16 Polymer.....	16
2.17 Summary.....	16

3.	<i>Drilling with compressed air</i>	19
3.1	<i>Air volume required</i>	19
3.1.1	Air Pressure	21
3.1.2	Safety	21
3.2	<i>Hole stability</i>	21
3.3	<i>Hole completion</i>	21
3.4	<i>Down-the-hole hammers</i>	22
3.5	<i>Drag blade drill bits</i>	22
3.6	<i>Power to crush</i>	22
3.7	<i>Hammer types</i>	22
3.8	<i>Non return valve</i>	23
3.9	<i>General tips for reliable hammer operation</i>	23
3.9.1	Lubrication	23
3.9.2	Rotation speed	23
3.9.3	Maintenance of drill bits	23
3.9.4	Hammer stripping	24
3.10	<i>Precautions with other parts of the drilling operation</i>	24
3.10.1	Shock absorbers	24
3.10.2	Correct adaptors	24
3.11	<i>Energy Efficiency</i>	25
3.12	<i>Difficult drilling – ‘boulders’</i>	25
3.12.1	Solutions	26
4.	<i>Drilling with foam</i>	27
4.1	<i>High velocity foam – air misting</i>	27
4.2	<i>Low velocity foam – stable foam column</i>	27
4.3	<i>Poor hole stability and a very messy operation</i>	27
4.4	<i>Non-return valve sub adapter</i>	28
4.5	<i>Where can it be used?</i>	28
4.6	<i>Well dippers</i>	28
4.7	<i>Foam pump types</i>	28
4.7.1	Hand Pump	29
4.7.2	Barrel Type Pump	29
4.7.3	Piston Pumps	29
4.8	<i>Foam inlet manifold</i>	29
4.9	<i>Mixing method</i>	29
4.10	<i>Adequate foam supply</i>	30
5.	<i>Logging of samples</i>	31
5.1	<i>Introduction</i>	31
5.2	<i>Fluid drilled holes</i>	31
5.3	<i>Drilling with compressed air</i>	31
5.4	<i>Sample collection</i>	32
5.5	<i>‘Chalking’ the drill pipe</i>	32

5.6	<i>Writing up of a log</i>	32
5.7	<i>Getting it right</i>	32
6.	<i>Borehole design</i>	35
6.1	<i>Hand pumps</i>	35
6.1.1	Sustainability	35
6.2	<i>Electric Submersible pumps</i>	36
6.2.1	Installation depth	36
6.2.2	Diameter of installation	36
6.3	<i>Spindle-driven pumps</i>	36
6.4	<i>Suction pumps</i>	38
6.5	<i>Hydrogeology</i>	39
6.5.1	Catchment area	39
6.5.2	Well-sorted sedimentary deposits	39
6.5.3	Poorly sorted sedimentary deposit	39
6.5.4	Porous rock.....	39
6.5.5	Fractured rock	40
6.5.6	Confined and unconfined aquifers.....	40
6.6	<i>Borehole siting near latrines</i>	41
6.7	<i>Well-lining materials</i>	41
6.7.1	Well casing.....	41
6.7.2	uPVC pipe	41
6.7.3	Well screen	41
6.7.4	Polyester 'Geotextile' Stocking	43
6.7.5	Use of fine slot well screens	43
6.7.6	Telescopic casing & screen	43
6.7.7	uPVC casing and storage	43
7.	<i>Well completion</i>	45
7.1	<i>Designing the well construction</i>	45
7.2	<i>Volume</i>	45
7.3	<i>Geology and Sampling</i>	45
7.4	<i>Depth to water</i>	45
7.5	<i>Pump insertion depth</i>	45
7.6	<i>Rough sketches</i>	46
7.7	<i>Check depth and diameter of hole</i>	46
7.8	<i>Preparation of materials</i>	46
7.9	<i>Forming points on uPVC pipe</i>	47
7.10	<i>Lowering uPVC pipe into a drilled hole-flotation effect</i>	48
7.11	<i>Clamping pipe</i>	48
7.12	<i>Completion of boreholes in hard rock</i>	48
7.13	<i>Cementing</i>	49
7.13.1	Displacement	49
7.13.2	Foot	49
7.13.3	Backfilling	49
7.14	<i>Sanitary seal</i>	49
7.15	<i>Bentonite pellets</i>	49

7.16	<i>Completion of boreholes in unconsolidated formations</i>	50
7.16.1	Step 1	50
7.16.2	Step 2.....	50
7.16.3	Step 3	50
7.16.4	Step 4	50
7.16.5	Step 5	50
7.17	<i>Surge block development</i>	50
7.18	<i>Compressed air development</i>	50
7.19	<i>Step 6 Final hole cleaning</i>	50
7.20	<i>Step 7 Sealing</i>	50
7.21	<i>Water level measurement</i>	50
7.22	<i>Well monitoring</i>	54
7.23	<i>Use of gravel pack</i>	54
7.23.1	Type of gravel.....	55
7.23.2	Preparation of gravel	55
7.23.3	Annular space	55
7.23.4	Gravel placement	55
7.23.5	Do it right or don't bother	55
7.24	<i>Rudimentary test pumping</i>	59
7.24.1	Step 1	59
7.24.2	Step 2.....	59
7.24.3	Step 3	59
7.24.4	Step 4	60
7.25	<i>A basic pump test</i>	60
8.	<i>Use of drilling technology with hand-dug wells</i>	61
8.1	<i>Hand-dug wells have many advantages</i>	61
8.2	<i>Disadvantages of hand-dug wells</i>	61
8.3	<i>Health aspects</i>	61
8.4	<i>Prospecting wet sites</i>	61
8.5	<i>Sub-Artesian - confined aquifer</i>	61
8.6	<i>Hard rock</i>	62
8.7	<i>Multiple holes</i>	62
8.8	<i>Economy of hole size</i>	63
9.	<i>Social responsibilities of the drilling operation</i>	65
10.	<i>When things go wrong</i>	67
10.1	<i>Stuck drill pipe</i>	67
10.1.1	By and large these are the steps to follow	67
10.2	<i>Fishing</i>	68
10.2.1	Magnet	68
10.2.2	Threaded pipes	68
10.3	<i>Borehole cameras</i>	68
	<i>Index</i>	71

Figures

Figure 1.1	Dragblade drill bit	3
Figure 1.2	Down-the-hole-hammer tungsten button drill bit	4
Figure 2.1	Progressive cavity pumping method	8
Figure 2.2	Fluid drilling – Effect of eroding diameter	9
Figure 2.3	Hydrostatic head	10
Figure 2.4	Recommended arrangements for surface settling pits	12
Figure 2.5	Well proportioned mud pits ready for filling	12
Figure 2.6	Functioning mud pits – slow moving flow for good settlement	12
Figure 2.7	Marsh funnel & jug	13
Figure 2.8	Mixing polymer	14
Figure 2.9	Individual clay cuttings washed to the surface	16
Figure 2.10	Clay collar	16
Figure 2.11	Effects of a clay collar in a hole	17
Figure 3.1	Compressed Air Drilling Schematic	20
Figure 3.2	Drilling with compressed air – having "struck" water	21
Figure 3.3	Down-the-hole hammer – with stripping clamp and spanner	22
Figure 3.4	Difficulties of drilling boulder-filled ground	25
Figure 3.5	Boulder-filled formation	26
Figure 4.1	Drilling with stable foam	27
Figure 4.2	Semi rotary hand pump	28
Figure 4.3	Typical foam injection manifold	29
Figure 5.1	1m samples laid out for view	31
Figure 5.2	Chalking pipe at datum	33
Figure 5.3	Chalking pipe at 1.3m depth	33
Figure 6.1	Lever Action Hand Pump / Direct Action Hand Pump	35
Figure 6.2	Direct Acting hand pump	36
Figure 6.3	Incorrect installation of electric submersible pump	37
Figure 6.4	Correct installation of electric submersible pump	37
Figure 6.5	Suction pump installation	38
Figure 6.6	Centrifugal pump drawing water from a 100mm (4") tubewell	38
Figure 6.7	Sedimentary formation	39
Figure 6.8	Rock types	40
Figure 6.9	Steel Slotted pipe	42
Figure 6.10	Placement of telescopic screen using simple bayonet tool	43
Figure 7.1	Construction of hollow weighted dummy – ready for filling for weight with cement	46
Figure 7.2	Heating up pipe end to form points	47
Figure 7.3	Casing points	47
Figure 7.4	Threading uPVC casing held securely on rope wraps	48
Figure 7.5	Well development with a surge block – Downstroke	51
Figure 7.6	Well development with a surge block – Upstroke	51
Figure 7.7	Airlift development Step 1	52
Figure 7.8	Airlift development Step 2	52
Figure 7.9	Airlift development Step 3	53
Figure 7.10	Airlift development Step 4	53
Figure 7.11	Air development manifold – Allowing discharge to atmosphere	54
Figure 7.12	Final stages of developing with compressed air	54

Drilled Wells

Figure 7.13	Fluid drilled hole naturally developed	56
Figure 7.14	Fluid drilled hole before development	56
Figure 7.15	Fluid drilled hole with placed gravel pack before development	57
Figure 7.16	Fluid drilled hole packed and developed	57
Figure 7.17	Use of small diameter pipe as centralisers	59
Figure 7.18	Gravel packing being added by funnel note water overflowing casing – gravel dropping below screened layer	59
Figure 7.19	Gravel packing – note water flow up has stopped – gravel landed above screen level	59
Figure 7.20	Machine test pump – discharged water being disposed of	60
Figure 8.1	Drilled hole either through bottom of existing well or drilled first then a dug shaft sunk around it	62
Figure 8.2	Drilled holes "radiating" out to intersect rock fissures	63
Figure 9.1	Something gone wrong	65
Figure 9.2	Borehole inadequately developed and left for user to sort out	66
Figure 9.3	Borehole properly developed and sealed ready for handover to user	66
Figure 10.1	Borehole camera	69
Figure 10.2	Camera shot of rock hole	69

Tables

Table 1.1	How to calculate hoist capacity for a drilling machine	5
Table 1.2	Cross sectional area of holes	5
Table 2.1	Formula to calculate required fluid circulation pump flow	7
Table 2.2	Fluid Flow in litres per minute required to drill holes of various diameters	7
Table 2.3	Recommended settling pit dimensions & borehole volumes	11
Table 2.4	Typical viscosities used for drilling	14
Table 2.5	Safety	15
Table 3.1	Formula to calculate required Air Compressor capacity	19
Table 3.2	Maximum drillbit size for specific compressors	19
Table 6.1	Comparison between Metric & English uPVC pipe sizes	41
Table 6.2	Minimum screen opening for a range of anticipated flows	42
Table 6.3	Formula to calculate screen open area	42
Table 7.1	Various hole volumes – in litres	58

Introduction

“Give a man a fish, and you feed him for a day. Teach a man to fish, and you feed him for a lifetime”.

For too many years provision of ground-water supplies to ‘developing’ countries has been the preserve of imported experts, who have bought with them construction technology designed and suited for use in ‘developed’ countries. It is time to replace this practice with training and more appropriate equipment so that the ability to extract water from boreholes becomes a permanently available skill in rural communities. In this way communities in the developing world will be able to meet their own demand for water at a cost they can afford to pay.

Extremely light and portable equipment can be used to drill holes into the ground to some quite appreciable depths. Drilling equipment is really very simple but its application requires sound common sense to achieve good results. To open a hole, an adequate method of spoil removal is essential. This needs to be suitable both for soft ground formation, which

needs supporting, through to hard dense rock, which must be cut or smashed. Once a hole is opened, it needs a final construction that will allow clean water to be produced. All the operations must adhere to some basic operational rules defined by existing field experience, together with accepted engineering theories, if the drilling and well construction are to succeed.

The skill of drilling and providing water is a talent available only to some. A drilling operation can seem to be an endless, dirty monotony of watching a drill-pipe rotate round and round, interspersed with bouts of effort to lift repeatedly pipe after pipe from a hole. However, a skilled driller is forever analysing the rumbles, rattles, surges and gurgles and trying to work out what in the earth is happening.

This manual explains in practical terms the basic drilling techniques. It describes the use of fluid circulation in soft ground formations, and compressed air and hammers for hard rock. It discusses well design, types of pump and their installation, screen selection, and testing.

1. *Drilling machines – The essential ingredients*

A rotary drilling machine does two essential jobs of work: it rotates the cutting head – ‘drill bit’, and hoists and feeds the drill pipe into and out of the ground. The capacity of a particular machine to accomplish these tasks will define its practical limitations. There are many other methods of drilling holes other than rotating drill bits. The most significant is the cable tool percussion method, which uses tools oscillating up and down on a cable to drill a hole. This manual does not address this method and restricts itself to rotating drilling machines.

1.1 *Rotation*

Drill bits, the tools that cut the ground, need to be rotated to cut or clear a round hole. Suitable power is required to rotate the drill bit providing the cutting force and to overcome any friction losses caused

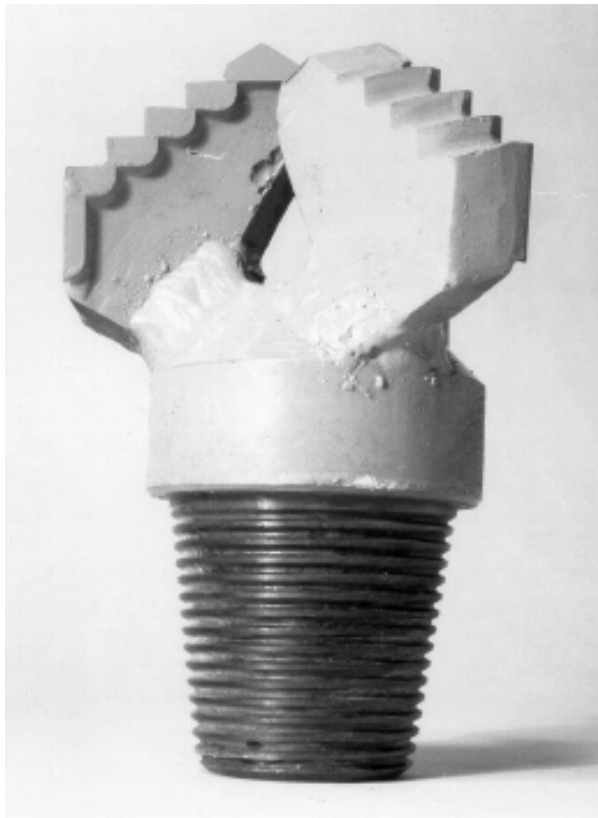

Figure 1.1 *Dragblade drill bit*

by the drill-pipe dragging on the walls of the borehole. A perfectly straight hole drilled in sand requires virtually no power because the sand offers little cutting resistance; stiff clay requires a drill bit with a sharp cutting edge and sufficient power to cut the clay; considerable force is needed to cut, crush or abrade hard rock.

1.2 *Torque & drill bits*

Rigs with limited or minimum power would use a drag blade: a steel, three-winged, tungsten-edged drill bit for sand, clays and any material that is cut into small pieces with little or no down force placed on the drill bit (Figure 1.1). The cutting edges of a drag blade are normally formed with a brazed tungsten carbide tip – both the tip and the steel tooth it is mounted on should have a ‘positive cutting rake’ so only the lead edge of the carbide scrapes the soil. It is often necessary to maintain bits by angle grinding away metal behind the cutting carbide to recreate the clearance behind the edge. Note that any steel angle grinder is suitable – but standard abrasive wheels will only cut the steel of the bit body not the tungsten carbide.

1.3 *Hard Rock drilling*

Harder materials are more easily drilled with a down-the-hole hammer (Figure 1.2). This tool is operated with an air compressor and works by hammering a heavy steel piston on to a slowly rotating ‘button’ percussion drill bit. This action introduces the extra energy necessary to break the toughest rock.

1.4 *Ground types*

It generally applies that ground that becomes solid enough to resist and slow down the penetration of a drag – blade - type drill bit will be solid enough to



Figure 1.2 *Down-the-hole-hammer tungsten button drill bit*

justify the use of a down the hole hammer. There is little place on small rigs to use a 'tricone rock roller' designed for rigs able to exert drilling pressure of 500 – 1000 kg per/cm diameter of drill bit and a torque sufficient to turn the bit under such a heavy crushing layer. To place weight on a drill bit would require a machine of sufficient high mass to resist being lifted off the ground.

1.5 *Drill pipe hoist*

Drill pipes are screwed together as drilling proceeds and the drilling machine must be able to support the total weight of all the drill pipe intended for use in the hole and the drill bit and in addition a safety factor should be used to overcome drag or friction encountered in a deep hole. The drilling machine must also have the ability to manoeuvre the drill-pipe into and out of a hole efficiently. A machine that takes 3 hours to insert 45 metres of drill-pipe and 5 hours to take it out again in a working shift of 8 hours is of no practical use. In general terms the longer the drill pipe and the taller the drill mast the quicker the machine will be in 'tripping in' (putting in) and 'tripping out' (taking out).

1.6 *Avoiding bent holes*

To keep boreholes clear of debris and as straight as possible, it is important to be able to control the speed and pressure of the operation. If the drill-pipe is lowered too hard or fast into sand or clay, the borehole will become blocked with material and pressing too hard will often cause the drill bit to deviate from the perpendicular. Formations containing hard layers due to the weathering process or chemical action can cause significant problems. When a drill bit is pushed against such a layer, the drill pipe above will be in compression and will bend, and the bit forced off centre, making the hole deviate. If a soft layer exists below, the drill pipe will straighten and the bit centralises once more, creating a step – that might stop casing entering the hole. This deviation is minimised by ensuring the drag blade bit has sharp cutting edges and is able to centre itself and steadily cut the rock – just sufficient weight should be added to the drill bit to allow a steady cutting rate. A simple welded 3 – wing stabiliser attached to a drill pipe and run above the bit will help keep the bit central and will grind away some of the edges of a step.

To conform completely to the established rules and theories of drilling the 'correct' solution is to use heavy 'drill collars' thick, walled steel drill pipes. These are placed directly behind the drill bit to make a heavy and rigid front or lead for the drilling string. To be fully effective the weight of the drill collars should exceed the required weight to make a drill bit cut; normally this is might be several tonnes. This keeps the drill pipe above in tension – hanging vertically like a pendulum on a string.

In practice, relatively large – diameter holes are required to be drilled to fit in collars of suitable weight and, with the trend towards smaller, lighter drilling rigs, it is a difficult job to transport and load these very heavy drill collars into the hole. The combination of sharp efficient drag blades and the down-the-hole hammer have effectively replaced the essential need for drill collars in just about all cases.

1.7 *Lightweight rotary rigs*

While being pertinent to all aspects of rotary drilling, this manual is aimed specifically at the smaller,

Drilled Wells

There have been two other significant developments in the last 30 years that have made drilling with lighter rigs entirely feasible. uPVC & Thermoplastic 'plastic' casing has become the preferred material used for well-lining. It is inert, non-corrosive and has the added benefit of being cheaper than steel and considerably cheaper to load, transport and unload. The formula (see table 1.1) for determining drill rig mast capacity ignores the insignificant weight of handling plastic casing. As a comparison 50m of 150mm - 6" - uPVC casing weighs 175 Kg while the equivalent in steel would weigh 1200 Kg. Therefore, if steel casing were used, it is the weight of the final casing that should be used to determine the size and load capacity of the drill rig mast and winch power. The second development is the down-the-hole hammer – developed for cost, effective, high production of blast holes in hard rock quarries and the mining industry. The down-the-hole-hammer has made drilling holes in hard rock normal, and this has become the commonest, and almost the cheapest type of machine drilled water supply borehole constructed. It removes the need for a drill rig to deliver the power required directly to cut rock – power is delivered direct to the hammer by compressed air developed by an air compressor.

2. Drilling with fluids

Fluid – plain water or water with additives – is forced by a pump down the centre of the drill pipe through the drill bit and back in the annular space formed between drill bit and the drill pipe to the surface into a ‘mud’-settling pit. The fluid does a number of key jobs, which each need to be properly understood to keep the hole under construction under the control of the drillers.

2.1 Adequate pump flow for diameter of well being drilled

As the fluid flows through the drill bit it picks up loose debris cut by the drill bit and carries it to the surface. It is only able to do this effectively if the water flow is sufficiently rapid to carry the particles

Up-hole velocity should range from 15–30 metres/minute and the required circulating pump capacity can be calculated using the following formula:

$$(D^2 - d^2) \times 7.5 = \text{litres/minute}$$

where:

D = drill bit diameter in inches

d = drill pipe diameter in inches

This gives the minimum flow requirement; double the figure for the maximum flow requirement

Example:

A 6" (150mm) diameter hole drilled with 3" (75mm) diameter drill pipe.

$$(6^2 - 3^2) = (36 - 9) = 27 \times 7.5 = 202.5 \text{ litres/minute minimum pump flow.}$$

Table 2.1 Formula to calculate required fluid circulation pump flow

Drill Bit Diameter		Drill pipe diameter					
mm's	Inches	58mm (2.1/4")		75mm (3")		88mm (3.1/2")	
		Min	Max	Min	Max	Min	Max
75	3"	30	60				
90	3.1/2"	54	108	25	50		
100	4"	82	164	55	110	25	50
125	5"	150	300	120	240	100	200
140	5.1/2"	190	380	160	320	135	270
150	6"	230	460	200	400	175	350
200	8"	450	900	415	830	390	780
250	10"	700	1,400	685	1,370	650	1,300
Useful conversion figures:							
Litres per minute		x.06	= Cubic metres per hour				
Litres per minute		x.22	= imperial gallons per minute				
Litres per minute		x 13.2	= Imperial gallons per hour				

Table 2.2 Fluid Flow in litres per minute required to drill holes of various diameters

from the bottom of the hole to the top. This speed depends on the flow capacity of the pump and the diameter of the hole and needs to be within a specific range. If it is too slow, debris will clog the hole above the drill bit and if it is too fast it will erode the wall of the hole and create problems with steady material removal as the drilling is deepened. Table 2.1 & 2.2 gives examples of fluid flow speeds required for various hole diameters.

2.2 Fluid circulating pumps: 'mud pumps'

Large, deep-hole drilling equipment invariably uses big and powerful piston pumps of the 'fixed displacement' type. This means that they are capable of delivering a steady flow rate at a given piston speed no matter what pressure restrictions are placed in drill-pipe and borehole. Lighter equipment invariably uses 'centrifugal' impeller pumps. These are capable of delivering large volumes (flows) of water with minimal power but they have very limited capacity to develop pressure (head). Any obstructions to the free flow of water through small, diameter hoses or fittings, or friction loss in long lengths of drill pipes increases the pressure head and this means that the flow drops off.

Progressive cavity pumps are also used successfully as mud pumps (Figure 2.1). By rotating a thread-shaped steel stator in a thread shaped rubber sleeve, the 'progressing cavity' formed induces flow and a pressure head. Like the piston pump this type of pump has a fixed displacement capacity – giving the same flow despite the pressure head put on it. With this type of pump, it is important to select a model that produces the required flow by keeping



Figure 2.1 Progressive cavity pumping method

the rotating speeds quite low. This will prevent high internal velocities of what becomes a very abrasive fluid, which could quickly wear pump internal components.

All pumps wear from pumping abrasive, soil-laden drill fluid, however effective the settlement, and will need replacement of wearing parts to keep them delivering required volume and pressure.

2.3 Flow and friction

When using centrifugal impeller pumps, care must be taken that the design of the equipment caters for easy flow (internal diameters as large as feasible) through swivels and drill pipes, and that pump speeds are carefully controlled to ensure that the flow is kept low at the top of a hole. This will prevent erosion (Figure 2.2) of the hole diameter and the engine speed should be increased to maintain the pump flow at the bottom of a hole where flow losses occur due to the friction build-up between the



pumped fluid and the confining drill pipe. The capacity of the pump to remove material steadily from the bottom of the hole dictates the penetration speed of the drill bit.

2.4 Preventing hole collapse - 'hydrostatic head'

By keeping a drilled hole full of water/fluid at least 3 metres above the natural water table exerts a

water pressure (a hydrostatic head) on the sides of the hole. This will prevent even the softest, finest sand from collapsing into a drilled well (Figure 2.3). It is important to maintain this level throughout the drilling, removal of the drill-pipe, and insertion of casing. Drilling on sites with unconsolidated geology that require support from collapse, and with high water tables (water resting less than 3 metres below surface) need special solutions. By using fluid additives of higher density than water, it is possible to build up the equivalent of 3 metres head: the density required is dependent on the exact column

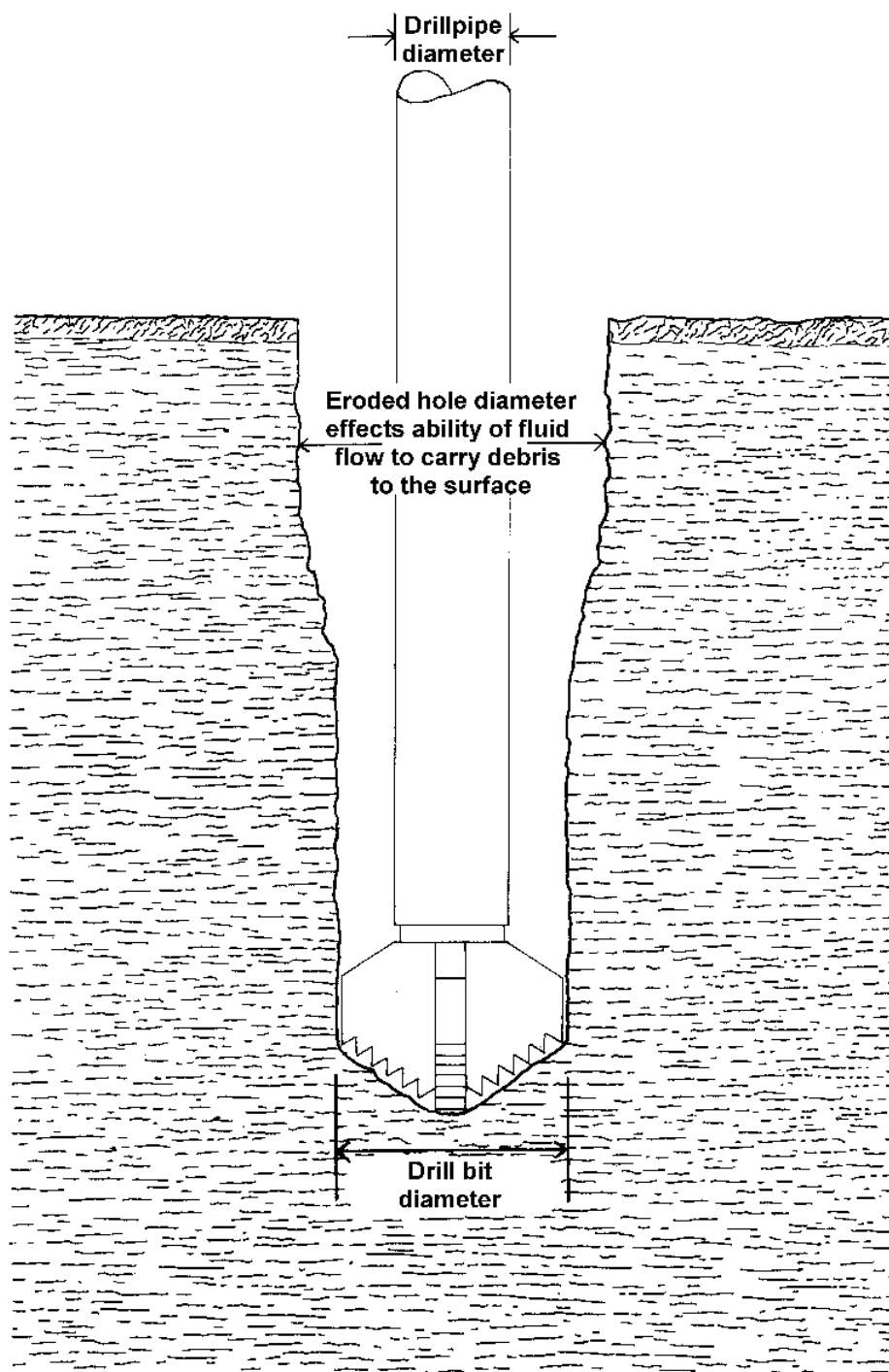

Figure 2.2 Fluid drilling - Effect of eroding diameter

of water required. Salt is one of the simplest and most available chemical additives that could be added to increase density of the drill fluid.

2.5 Hole Cleaning

The up hole velocity of 15 to 30 metres/minute means that it takes several minutes to achieve full circulation of the fluid and carriage of debris from the hole base to the surface. The time debris takes being lifted is not just a calculation of the up hole velocity against hole depth as the debris is not fixed into the fluid but is dropping through the rising

column of liquid. Quite simply the deeper the hole the longer the full cycle of cleaning will take.

Having drilled each successive drill pipe to depth the drill pipe should be left at the hole base with the fluid circulating and an amount of time, think minutes not seconds, to be given to allow the hole to clean – to circulate clear the debris.

A clean hole can be easily seen when changing, adding, a drill pipe. Having stopped the mud pump and 'broken' that is unthreading the drill pipe connection between the rig rotary head and lifted the head clear the column of fluid in the drill pipe should

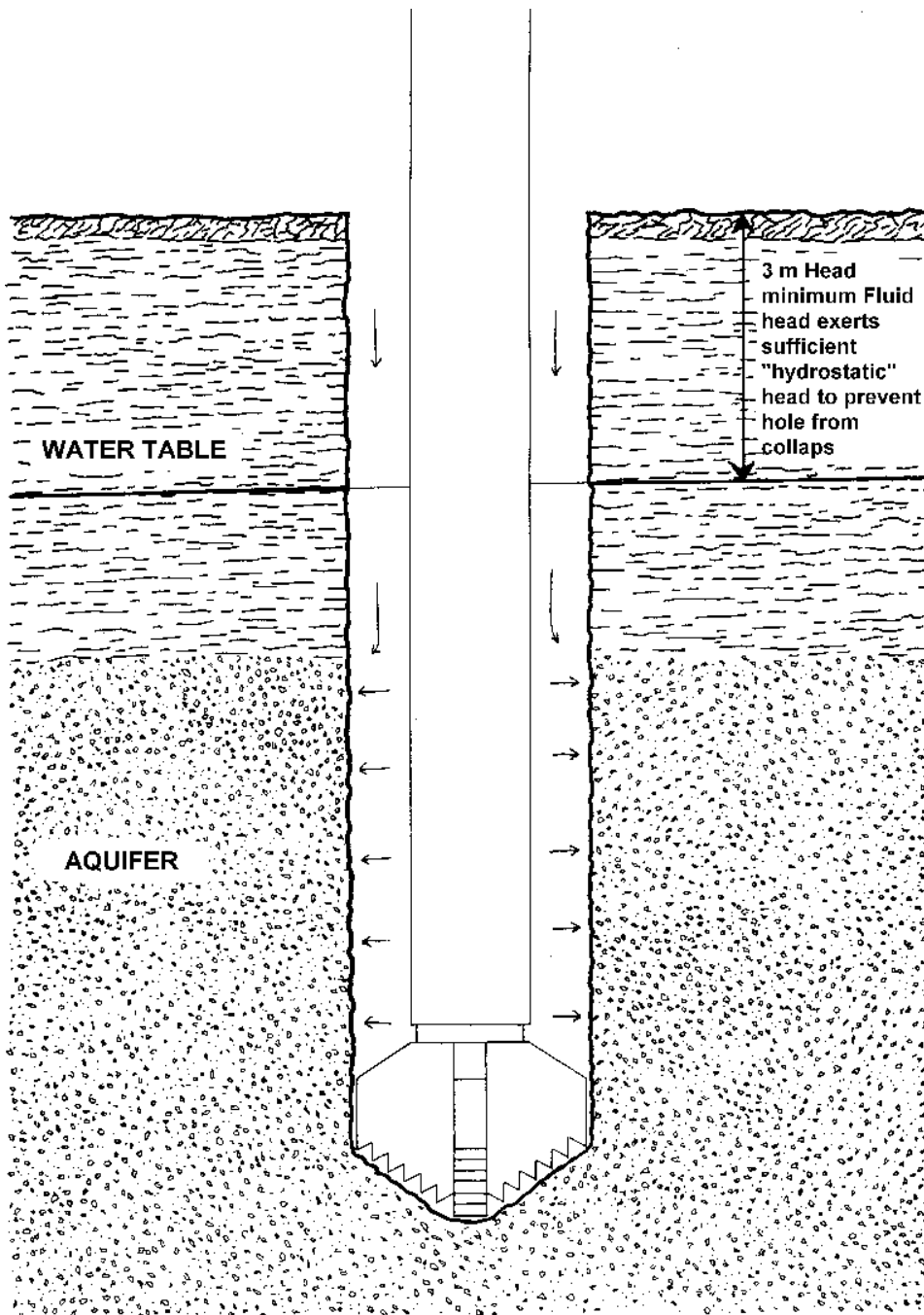

Figure 2.3 Hydrostatic head

quickly drop the short distance to the level of the fluid resting in the borehole. A hole still full of debris or with a blockage will result in fluid flowing out of the drill pipe. Why? It is the manifestation of different density that is being seen – if the fluid in the annulus of the borehole has a load of debris in suspension it is heavier or denser than the clean 'settled' fluid in the centre of the drill pipe so when left open to atmosphere – when the drill pipe connection is broken and lifted clear - the heavier fluid in the annulus will displace the lighter fluid in the centre of the drill pipe.

The more 'out of balance', the bigger the flow out of the drill pipe the more debris is being left in the hole. Seen early a little more time can be given to hole cleaning and the problem solved – left unresolved will mean debris could flow back into the restricted drill pipe bore and this will result in a physical blockage that simply cannot be cleared by the pressure head of the fluid.

2.6 Adequate settling pits

For the circulating fluid to do its job the settling pits must be of an adequate size to enable the debris to settle from the fluid before it is pumped back down the drill-pipe. The practical convention is to have the surface pits volume three times the total volume of the hole to be drilled (see Table 2.3) and to arrange the pits so as to encourage maximum settlement of material from the fluid. The pit dimensions should encourage flow, of the fluid, to slowly flow through the mud pit system to induce as much settling out as possible of 'fines' from the fluid (Figure 2.4). Ideally, the width should equal the depth but local topsoil conditions might influence pit construction considerably. It is always difficult to balance the available transportable water with which to drill and the energy and vigour of the drill crew to dig out the optimum size mud pit. The quality and efficiency of construction of the final drilled hole will benefit from an adequate volume of water.

Borehole Diameter & Depth	Volume of hole	Approx Volume of hole*	Required Volume of Settling Pits	Settling Pit - Recommended dimensions in metres			Suction Pit - Recommended dimensions in metres		
				Length	Width	Depth	Length	Width	Depth
100 (4") x 25m	0.20	200	600	0.8	0.6	0.8	0.6	0.6	0.6
100 (4") x 50m	0.39	400	1,200	1.2	0.8	0.8	0.8	0.8	0.6
100 (4") x 75m	0.59	600	1,800	1.6	0.9	0.9	0.9	0.9	0.7
100 (4") x 100m	0.79	800	2,400	1.6	1.0	1.0	1.0	1.0	0.8
150 (6") x 25m	0.44	450	1,350	1.2	0.9	0.8	0.9	0.9	0.6
150 (6") x 50m	0.88	900	2,700	1.6	1.1	0.9	1.1	1.1	0.7
150 (6") x 75m	1.33	1,300	3,900	2.0	1.3	1.0	1.3	1.3	0.8
150 (6") x 100m	1.77	1,800	5,400	2.2	1.4	1.1	1.4	1.4	0.9
200 (8") x 25m	0.79	800	2,400	1.6	1.0	1.0	1.0	1.0	0.8
200 (8") x 50m	1.57	1,500	4,500	2.1	1.3	1.1	1.3	1.3	0.9
200 (8") x 75m	2.36	2,350	7,050	2.4	1.5	1.3	1.5	1.5	1.1
200 (8") x 100m	3.14	3,150	9,450	2.8	1.6	1.4	1.6	1.6	1.2
250 (10") x 25m	1.23	1,200	3,600	1.9	1.1	1.2	1.1	1.1	1.0
250 (10") x 50m	2.45	2,500	7,500	2.6	1.4	1.4	1.4	1.4	1.2
250 (10") x 75m	3.68	3,700	11,100	2.8	1.7	1.5	1.7	1.7	1.3
250 (10") x 100m	4.91	4,900	14,700	3.2	1.8	1.7	1.8	1.8	1.5

All Mud settling pits will require topping up during the drilling operation. The amount of water required to 'top up' would depend on the porosity of the formation being drilled and the viscosity of the polymer. It is recommended a minimum of the ***Final Hole Volume** should be available as stored water on the drill site to make up losses.

Table 2.3 Recommended settling pit dimensions & borehole volumes

Drilled Wells

In most cases, surface topsoil will be stable enough to construct settling pits – clay being absolutely ideal material. If the pits are in soft permeable soil they can often be satisfactorily plastered with neat cement & water or possibly sand & cement to seal and strengthen the sides (Figure 2.5). Alternatively local clay could be used to line the pits or plastic

sheets used – take care to ensure water cannot flow behind any sheet.

Other key attributes of good settling pits are slow flowing level and flat channels running away from the borehole (Figure 2.6). These provide fast settling as well as, good places to collect borehole samples

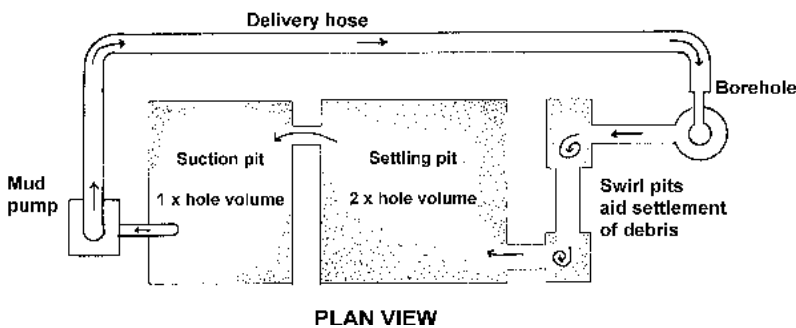
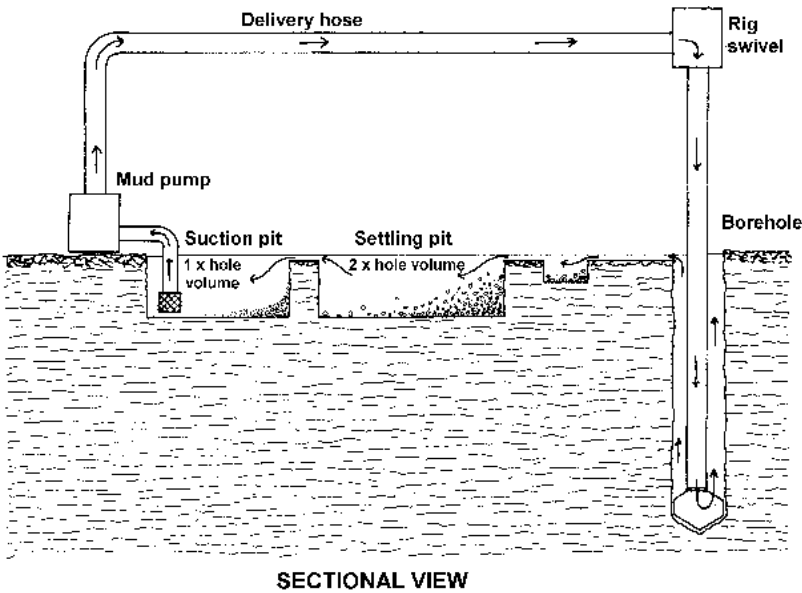

Figure 2.4 Recommended arrangements for surface settling pits



Figure 2.5 Well proportioned mud pits ready for filling



Figure 2.6 Functioning mud pits – slow moving flow for good settlement

and shovel clear a great deal of the bulk of debris being drilled. The pump suction line needs to be hung on a support, lifting it from the settling pit bottom but ensuring that it is sufficiently below the pit level so the pump is fed with as clean and settled fluid as possible.

By planning the design of mud settling pit in advance, the major construction can be accomplished before the main drilling equipment is taken to the site. Mud pit construction can often use labour provided by the local community.

2.7 Drill fluid additives

Drilling performance is much improved by using additives mixed with water. Broadly two main types of additives are used: bentonite and polymers.

2.7.1 Bentonite

Bentonite is a natural clay, which, when mixed in sufficient volume, will increase viscosity. Bentonite produces a 'solids-based fluid' that works extremely well but will line the borehole with a 'wall cake' of bentonite clay. This is impervious to water and will need dispersal on completion of the hole with specific chemical or mechanical methods. Bentonite also needs to be left for 12 hours after initial mixing to build sufficient viscosity. For these two reasons, bentonite is not normally recommended for construction of water wells.

2.7.2 Polymers

The best water-well additives are natural polymers, which, when mixed with water, thicken into a viscous fluid. This fluid can carry debris at much slower pumping flow rates and will also line the borehole walls to prevent heavy seepage of fluid into the formation. It thus helps to maintain the 'hydrostatic head' of fluid above the natural water table, keeping the borehole from collapse. It also prevents permeable water-bearing layers from contamination by the invasion of fine 'silty' particles. Most polymers are natural products used as stabilisers and thickeners in the processed food industry and are biodegradable, so the viscous properties will disappear naturally in a few days. Alternatively, introducing chlorine solutions can accelerate their dispersal.

2.8 Viscosity measurement

Drill-fluid viscosities are measured with a Marsh Funnel (Figure 2.7). This is a simple device used to measure the rate at which a given volume of fluid (1 litre) drains through a funnel with a 5-mm spout. The more viscous the fluid, the longer the funnel takes to drain.

Alternative devices

Although the Marsh Funnel is used throughout the drilling industry it is a relatively simple device for comparing viscosities. Any funnel or similar device could be adapted to give comparative measurements of the viscosity of clean water and drill fluid. For example, a nail hole in the bottom of a soft-drink can allow a timed reading of clean water measured against a mixed fluid and allow repetitive comparison between various drill fluid mixes.

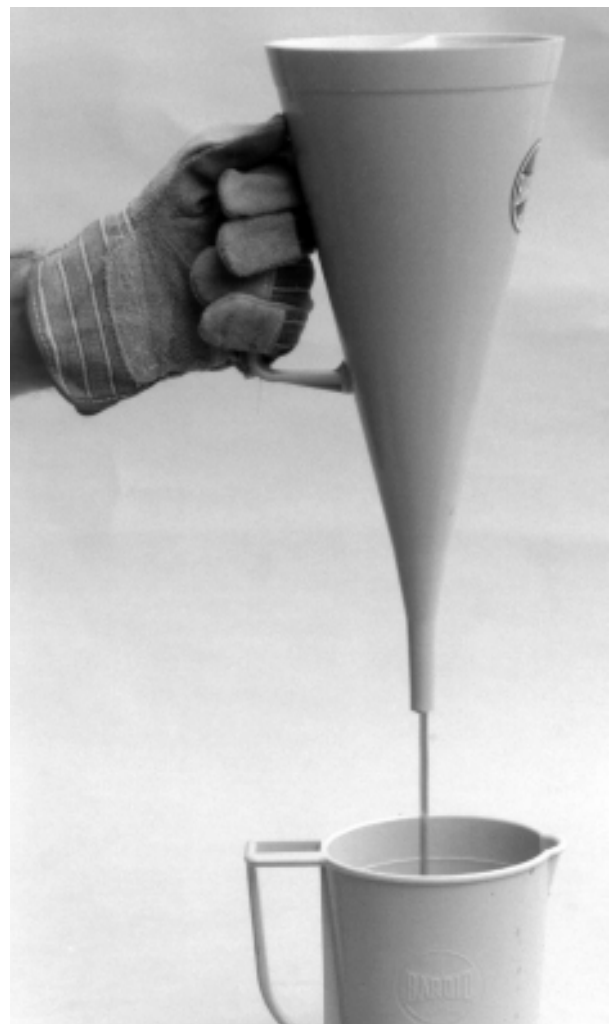

Figure 2.7 Marsh funnel & jug

2.8.1 Mixing volumes

At the start of drilling a hole, it is relatively easy to match the mud pit volume with the fluid additive being used. However, as drilling continues and pits need topping up it is easy to lose control of the viscosity of the drill fluid. This can lead directly to some very specific difficulties discussed below.

2.8.2 Correct viscosity

It is important to get the viscosity just right for the job in hand. If a fluid is too viscous ('thick and heavy') for the formation being drilled, it becomes laden with borehole debris. This gets re-circulated through the pump, rig swivel, drill-pipe and drill bit and will cause considerable wear to components as well as stop the ability of the fluid to pick up more debris.

If a fluid is too light ('runny') it can soak into the formation being drilled, resulting in a loss of fluid in the pits. This could lead to borehole collapse and will also potentially damage water-bearing layers by blocking the pores with fine borehole debris carried into the formation by the fluid (Table 2.4).

2.9 Tips on the use of polymers

Polymers are quite expensive and to use more than is required is a waste of money.

<i>Drilling Condition</i>	<i>Marsh Funnel seconds</i>
Normal drilling	35-40
Coarse permeable sands/gravels	50-60
Areas of high permeability	60-80
"Pill" 100+	
Note: It takes 27 seconds for clean water to drain through the spots of a Marsh funnel and fill 1 litre jug	

Table 2.4 Typical viscosities used for drilling

Mixing

Generally, polymers are supplied as very fine white or off-white powders. They are best mixed into a jet of water at a rate that prevents lumps of powder forming on the surface (Figure 2.8) . All polymers take a period of time to 'yield' -to build viscosity: generally 30 minutes is the minimum time needed for any significant yield to take place. It is always best to allow the maximum time possible and to mix the polymer early during the setting up of the rig, so that it has yielded sufficiently by the time drilling starts. Water quality can effect how polymers mix and yield, and mixes may require adjustment. In rare situations, the mix water might require chemical correction to enable a polymer to mix and yield.

2.10 Ability to biodegrade

As discussed earlier, polymers based on natural ingredients are biodegradable. With time and bacterial action they will breakdown and smell rotten! Warmth and presence of bacteria will speed the breakdown. Generally a natural polymer can be expected to last 4 days, but perhaps just 2 or 3 in tropical conditions, and certainly it would be best to avoid mixing polymer just before a long-weekend work break.



Figure 2.8 Mixing polymer

2.11 Dispersing

On completion of the hole, the job of the polymer is complete and it is important to get rid of it as thoroughly as possible. If this is not done, the resultant rotting and smelly fluid will affect water quality, at least during initial operation of the well. Removal of the polymer is best achieved by displacing the mixed drilling fluid from a completed hole with clean water – pumping clean water down the casing out through the well screen, thus displacing the drilling fluid to surface. It is also advisable to pump out the settling pit – spreading the fluid over a flat area quickly breaks down the polymer and prevents a unpleasant smell that would result from leaving a bulk of fluid in the settling pits.

2.11.1 Chlorine

In addition, most polymers are broken down by the addition of chlorine. Chlorine is available in many forms, from simple domestic disinfectants through sodium hypo-chlorite solutions to stabilized powders and granules. A well that has been largely flushed clear of residual drill fluid might require an addition of 10 ppm (parts per million) of free chlorine, whereas a hole full of viscous fluid will need 1000 ppm. The added chlorine will destroy the viscosity properties of the polymer, aid well development, kill the bacteria feeding on the polymer and sterilise the well. Any added chlorine must be pumped out or the well rested until all traces, both smell and taste, disappear (Table 2.5).

2.12 Lost circulation / fluid losses

As drilling proceeds, a little loss of fluid volume can be expected because the liquid will be absorbed into the borehole walls to depth of a few centimetres.

SAFETY NOTE

Chlorine needs careful handling. It is hazardous both to exposed skin, eyes and as a gas given off during use.

Follow the manufacturer's recommendations for safe use.

Table 2.5 Safety

A suitable volume of water/ready-mixed drill fluid should be available to steadily make up these losses. Larger or complete losses need to be controlled in order to maintain the process of debris removal and to keep a 'hydrostatic head' on the formation being drilled.

2.13 Remedies

There are several remedies: three are listed below.

2.13.1 'Pills'

For partial loss into water-bearing zones, increase the viscosity of the fluid until loss slows. If necessary prepare a 'pill' – a 200-litre drum or similar volume of very thick polymer, which is just about pumpable. Alternatively, very thick polymer can be poured by buckets into the annulus of a borehole. Pump or bucket this into the hole and allow it to sit for a while (30/60 minutes).

This is where drilling relies on human skill, the ability to anticipate the problem and to remedy it rapidly and efficiently. A 'pill' left to stand to yield viscosity and be ready to be used before severe loss of circulation occurs, requires that someone in the drill crew has spotted the formation changing, seen signs of fluid loss and acted immediately.

2.13.2 Fibre

For partial or complete loss into areas of a hole not likely to produce water, introduce fine fibre into the fluid – sawdust, grain husks, cow dung (dried and crushed). This will block the pores into which fluid is being lost. Mix the fibre with drill fluid in a 200-litre drum so that it is just pumpable and pump into the hole, ensuring that the volume pumped is sufficient to displace clean drill fluid from the portion of the borehole absorbing fluid. As this fluid seeps or flows into the porous formation the fibre will block the pores, slowing seepage flow until normal fluid circulation can resume.

It is not advisable to use this method in the area of the hole that bears ground water because it is difficult or even impossible to develop out the fibre after screen is placed in position.

2.13.3 Liquid Cement

For losses uncontrollable by the first two methods liquid cement can be used as a last resort to seal off a specific zone permanently, particularly a fissure or similar formation that fibre alone is unlikely to block.

2.14 Drilling Clay

Thick, solid bands of clay are frequently encountered during drilling. The key to the efficient drilling of clay is:

To drill with a sharp-toothed drag blade drill bit, which penetrates slowly and steadily to encourage small curls of clay to be steadily washed to the surface (Figure 2.9). If the bit is pushed too fast or too hard, clay will begin to clog the hole above the drill bit. Constantly monitor the returning flow to see that flow is maintained correctly and cuttings are being removed in proportion to the drilling penetration.

2.15 Collaring

Clay is very prone to 'collaring', in which complete rings of sticky clay form above the drill bit (Figure 2.10). Once formed they have to be removed or the problem gets worse very quickly. Maintaining the flow and reaming the drill bit up and down the hole repeatedly can push the collar to the surface where it will be pushed out of the hole as a solid mass (Figure 2.11). It can then be removed smartly by an alert drilling crew armed with shovels or spades. Sometimes it might be necessary to ream back the



Figure 2.9 Individual clay cuttings washed to the surface

drill bit to the surface to remove very obstinate sticky collars. It is important to ensure such collars are completely removed because they can hold up the insertion of screen and affect the placement of formation stabiliser or gravel pack.

2.16 Polymer

Polymer drill fluids coat individual clay cuttings and can largely prevent collars forming. If the collaring is especially bad, salt added to the drill fluid will help keep clay drill cuttings separate.

2.17 Summary

Fluid drilling as a drilling method can look quite daunting and complicated. However, this need not be the case if each required attribute described above is addressed in order.

The mud -pump specification, its flow (volume) and pressure (head) with the internal restrictions of drill



Figure 2.10 Clay collar

pipe will define the possible diameter a well can be drilled. A target depth leads to determining the size of the settling pits and the amount of water required to fill them by transport or nearby source. Knowing the water volume allows for a suitable mud to be mixed and drilling to commence.

Good site management is key: ensuring make-up water is continually available as required; ensuring

that labour is organised with routine tasks of collecting samples, shovelling clear the bulk of debris and mixing up additives through to the well-lining materials being available for insertion immediately the hole is complete.

Invariably, an analysis of the drilling set-up for mud/fluid drilling will reveal what item is incorrect or unsatisfactory and why things start to go wrong.

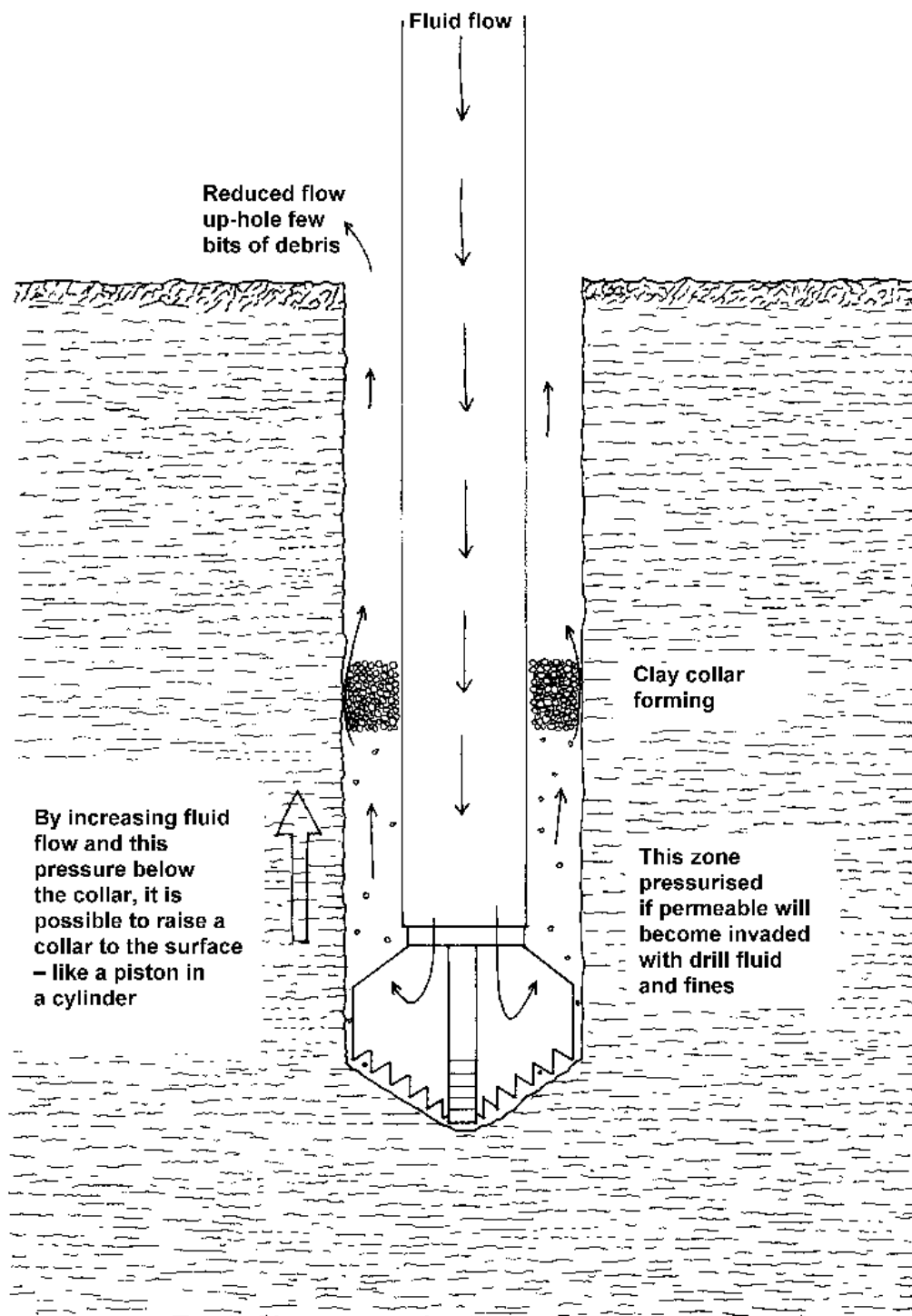

Figure 2.11 Effects of a clay collar in a hole

3. Drilling with compressed air

Drilling with compressed air uses an air compressor, invariably a diesel-engine-powered piece of construction plant, to produce and blow compressed air down through the centre of the drill-pipe and up through the annular space formed between the larger drill bit diameter and smaller drill pipe diameter. The rising column of air carries borehole debris to the surface and when matched with a down-the-hole hammer introduces energy directly to the hole bottom to smash the hardest of rocks.

3.1 Air volume required

The size of an air compressor is linked to the possible borehole diameter; it is essential to the drilling process that the air travels up the hole fast enough to carry debris with it. Note that this speed is considerably faster than water/fluid circulation because air is less able to support material than water (Tables 3.1 & 3.2). Air Volume is specified by compressor manufacturers in units of free air delivered M³/Minute

Up-hole velocity should range from 900–1200 metres/minute and the required compressor size can be calculated using the following formula:

$$(D^2 - d^2) \times 0.5 = \text{Metres}^3/\text{minute}$$

where:

D = drill bit diameter in inches
 d = drill pipe diameter in inches

This gives the minimum flow requirement; add one third of this value for maximum or optimum flow requirement

Example:

A 6" (150mm) diameter hole drilled with 3" (75mm) diameter drill pipe.

$$(6^2 - 3^2) = (36 - 9) = 27 \times 0.5 = 13.5 \text{ Metres}^3/\text{minute}.$$

Table 3.1 Formula to calculate required air Compressor capacity

Compressor Volume			Maximum Drillbit Diameter					
m ³ /min	litre/sec	CFM (feet ³ /min)	Drillpipe diameter 58mm (2.1/4")		Drillpipe diameter 75mm (3")		Drillpipe diameter 88mm (3.1/2")	
			mm's	inch's	mm's	inch's	mm's	inch's
3	50	100	85	3"				
5	80	175	100	4"	115	4.1/2	125	5"
7	120	250	115	4.1/2"	125	5"	140	5.1/2"
10	175	375	125	5"	140	5.1/2"	150	6"
13	210	450	140	5.1/2"	150	6"	165	6.1/2"
17	280	600	150	6"	165	6.1/2"	175	7"
Useful Conversion figures:								
m ³ /min			x 16.66	= litre per second				
m ³ /min			x 35.31	= cubic feet per minute (CFM)				

Table 3.2 Maximum drillbit size for specific compressors

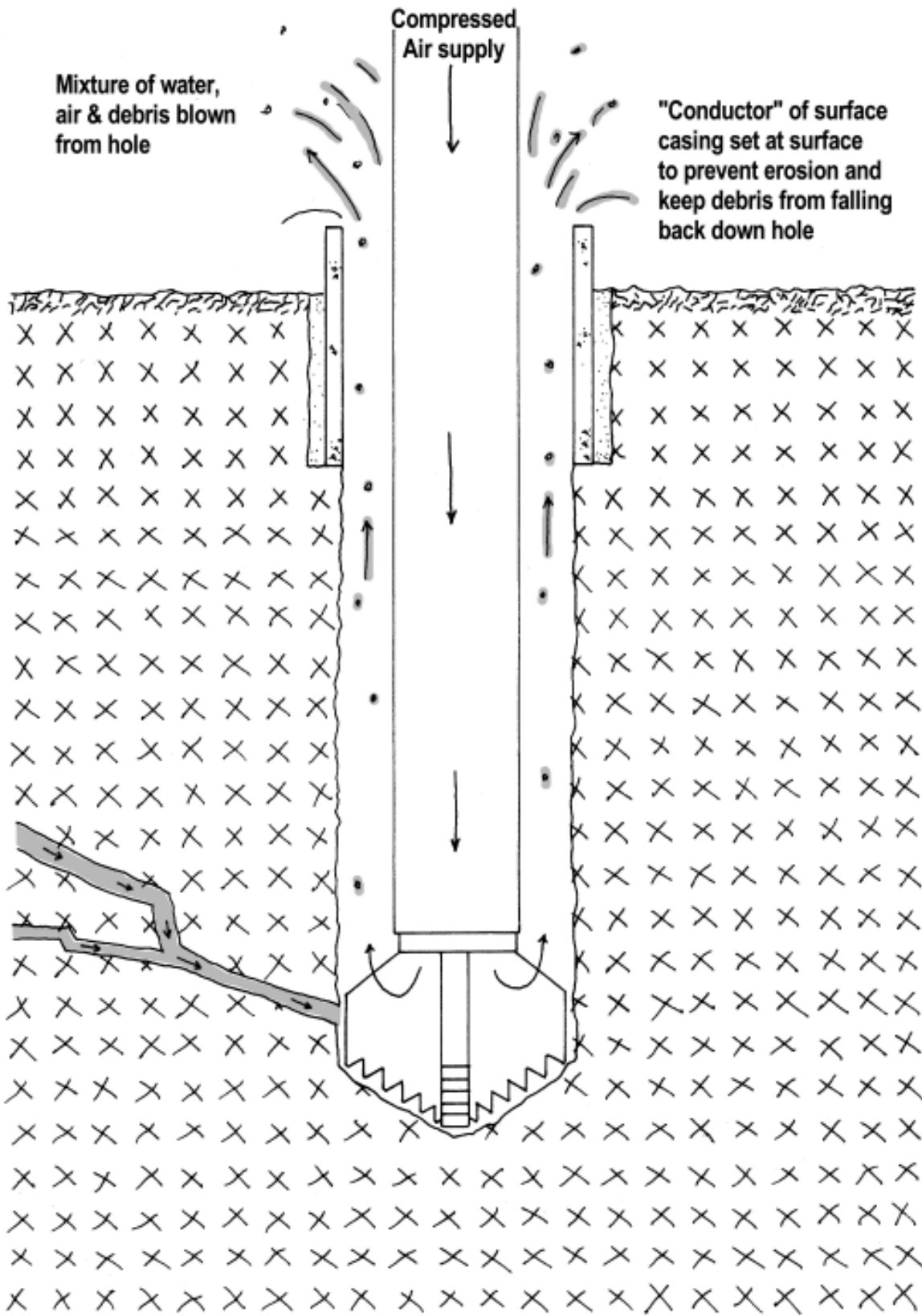

Figure 3.1 Compressed Air Drilling Schematic

(Cubic Metres delivered per minute) Litres/sec or CFM – Cubic Feet per minute. All these are units of flow or volume and not pressure or force.

3.1.1 Air Pressure

The other attribute specified by compressor manufacturers is the pressure a unit can develop in Bar or psi (pounds per sq inch). Most industrial units will develop a minimum of 6 bar (100psi) with specialist units able to develop pressures of 20 Bar (300psi). It is the air volume that cleans the hole and is the most essential requirement of a drilling compressor. Pressure allows more energy to be delivered to the piston of a down-the-hole hammer – thus imparting more energy to the drill bit and allowing a faster penetration rate. Pressure is also required to lift clear any resting column of water from a borehole – A 6 Bar compressor will just about lift a 60 m column of water from the base of a hole. Therefore reasonably deep holes in rock with a high groundwater rest level might require deployment of a high-pressure air supply just to be able to lift clear stored columns of water.

3.1.2 Safety

Compressed air (pressurised air), particularly when available in high volumes as on drilling operations can be and has proven to be lethal. Typically a hose bursting or an end-fitting breaking will cause the broken hose end to snake around with considerable random force and speed. Ensure all connecting hoses and fittings are of adequate pressure rating – most good quality hose will have a pressure rating written on its outer sheath. In Europe, safety law insists hose are 'whip checked' that is fitted with safety chains or steel cable fastened independently to the connected machine and hose outer sheath. Look after flexible hose that joins a compressor to a drilling rig – avoid mechanical damage such as squashing or kinking – check hose couplings are fitted tightly and that bolts remain tight. Replace any hose that has become visually weakened by use and age, for example by having a cracked outer sheath.

3.2 Hole stability

Unlike water/fluid drilling, air provides no protection from collapse of borehole walls. Indeed, if air is used

in soft formations the walls easily erode and the drilling process has to stop. It is important to protect the top lip of the hole from erosion and ensure the diameter of the hole is evenly maintained from the base to the top. A short piece of casing pipe with bore just a few mm larger than the drill bit should be set as a 'conductor casing' at the top of the hole it should be set at a depth of 500mm and protrude 100-300mm above the ground. By having a lip protruding allows debris to blow clear but not drop down the hole when airflow is turned off. Much longer lengths of casing are, of course, required when the top surface is soft for some depth (Figure 3.1).

3.3 Hole completion

It is often said the harder the geology – the rock - the easier the drilling construction is – this is true assuming the correct tools are used.

In consolidated rock it is normally possible to leave the drill-pipe at the bottom of the hole blowing the discovered water to the surface. The water will initially be contaminated with borehole debris but will gradually clean up until it is crystal clear (Figure 3.2). 'Surging' might help holes with low a flow, which is accomplished by turning the air supply on and off repeatedly. The resultant rising and falling column of water will clean the borehole walls, washing into and out of water bearing fissures and clearing them of the borehole debris.



Figure 3.2 *Drilling with compressed air – having "struck" water*

3.4 *Down-the-hole hammers*

The use of compressed air provides a method of introducing considerable energy into the hole-drilling process. As discussed earlier, in a soft formation this energy is misplaced and is likely to lead to extensive hole erosion or collapse. Just imagine for a moment the effect of pointing a high-pressure air jet at a pile of loose sand. However, when this energy is harnessed to an appropriate tool – a down-the-hole hammer (Figure 3.3) – the energy will be directed to smash and pulverise hard rock and then blow it clear of the hole.

3.5 *Drag blade drill bits*

If the formation is soft enough to be cut with a drag blade drill bit but hard enough to support itself it can be drilled using a drag blade with air flush to blow clear the debris. A hammer is only essential when the rock cannot be efficiently cut with a drag blade drill bit.

3.6 *Power to crush*

The down-the-hole hammer is an invaluable complementary tool for all sizes of rotary drilling machines. All that is needed is to place a nominal down load on the hammer and rotate at a low speed. The compressed air energy will be able to drill the very hardest rock, which is impenetrable using conventional drill rig power.

These are highly developed mass-produced tools pioneered in the rock quarry and mining industry, where the cost per metre of drilling blast-holes in hard rock makes a huge commercial impact. The drilling bit is a hardened-steel, domed percussive shaped bit with shaped passages for compressed air to flush debris from the hole bottom. Its face is set with tungsten carbide buttons. The drill bit is fitted



Figure 3.3 *Down-the-hole hammer – with stripping clamp and spanner*

by loose fitting splines to the base of the down-the-hole hammer and the whole unit is pushed lightly against the rock face at hole bottom and rotated slowly so the tungsten buttons are able to strike across the entire hole base. The hammer device comprises of an air distribution network in a steel cylinder, which is arranged to pass air from alternate ends to an internal heavy sliding steel piston. With the drill bit pushed against the hole bottom, the piston is picked up by the air supply delivered through the centre of the drill pipe and then thrown down on top of the percussive drill bit, delivering a huge ‘hammer blow’ of percussive energy into the drilling bit. This sequence is repeated several times a second. The higher the compressor pressure, the faster the piston will be thrown on to the bit and the more energy will be delivered to the drill bit.

To stop the piston hitting the percussive drill bit, the hammer attached to the drill pipe is lifted a few cm and the drill bit slides out of the hammer body, changing the effective air ports. The piston remains stationary and the compressed air is discharged continuously through the drill bit allowing the borehole to be flushed. Indeed as the piston is working the compressed air is exhausted through the drill bit blowing debris clear of the hole bottom during the drilling action.

3.7 *Hammer types*

There are two types of down-the-hole hammer construction: ‘valved’ and ‘valveless’. The ‘valved’ hammer has a flap valve to regulate compressed air to control the piston stroke and is restricted to low operating pressures. It is also prone to becoming choked with too much foam/water addition (see foam drilling). Valveless hammers now predominate. They have contoured pistons and cylinders to control airflow, and are suitable for work at high pressure and allow foam/water injection to pass through easily

A hard dry rock can be drilled constantly and the air discharged through the hammer will lift all the material being cut to the surface, particularly if the compressor is sized generously for the hole diameter being drilled. At the hole base, after a drill pipe has been completely drilled, the hammer bit can be lifted clear of hole bottom and the increased volume of flushing air will remove the remaining particles

in a few seconds. When a hole is meeting water and becoming sticky, or the ground is broken or soft, the regular removal of spoil will stop. In this situation addition of foam or water injection might help, but the driller might have to lift clear the hammer each half metre to use the increased air flush to clean the hole.

However powerful a down-the-hole hammer is capable at smashing into hard rock, it can take a very insignificant rock particle or damp collared layer of fine dust above the hammer to jam it tight in a hole.

3.8 *Non return valve*

When drilling 'under water' after water has been struck it is essential that the hammer is fitted with a non-return valve. This allows air to be delivered through the drill pipe to the hammer but does not allow air to pass through the hammer back into the drill pipe. This allows drill pipe to be disconnected to add further pipes, and prevents water dirty with borehole debris from entering the hammer piston and valve mechanism. Most modern hammers always have these valves fitted but they need to be kept in good working order.

3.9 *General tips for reliable hammer operation*

3.9.1 *Lubrication*

Hammer manufactures universally like to see their products continually lubricated with a mist of special fine lubricant added into the air supply. Airline lubricators are often part of modern drilling packages. In practice, down-the-hole hammers continue to operate reliably without the special oil required, which can be difficult to obtain means that it is common to see a hammer operation without the benefit of continual lubrication particularly in remote locations. Invariably the water-well driller will like and prefer to use water/foam injection to keep the hole being drilled clean and non-sticky and in part the water injection provides some lubrication.

One common practice, in place of a functioning airline lubricator, is for the drill crew to pour a small capful of clean oil into the centre of the drill pipe each

time a new drill pipe is added – this helps maintain some lubrication and quickly becomes an established drill crew routine.

The compressed air needs to be delivered clean to the hammer. Ideally drill pipe used for mud drilling should be kept separate from drill pipe used for hammer drilling. If this is unavoidable and the same drill pipe has to be used for both types of drilling, it will help to keep the pipe as clean as possible internally – using threaded plastic end caps help a lot. Often drill crew adopt the routine of blowing through each new pipe added to the drill string. This is done by adding a drill pipe to the rotary head first and then covering the drill pipe already in the hole at the rig table. A blast of a few seconds of compressed air will blow through the worst of any contamination in the new drill pipe.

On completion of a hole and when the hammer has been brought back to surface a small cupful of oil should be poured into it and air blown through to lubricate the sliding parts this is particularly necessary when it has been used with water/foam injection. As the hammer is removed or added to the rig it can be turned over end to end by hand to check the piston is able to freely slide up and down the inside the hammer body it will make a dull thunk as it moves up and down – choose a moment when engines are turned off! Many drill crews will check the hammer is operating correctly before inserting into the hole by connecting it to the rotary head and hammering a few blows against a short stout piece of timber -never use steel because it will break the tungsten buttons.

3.9.2 *Rotation speed*

Rotation speed should be from 20/30 revs/minute on most small hammers. Rotation is required only to allow the tungsten carbide buttons to strike the hole bottom uniformly. Rotating too fast adds nothing to the drilling performance. Evidence of running too fast can be seen by looking at the outer row of buttons of a worked button bit will show wear and flattening significantly before the inner buttons.

3.9.3 *Maintenance of drill bits*

The tungsten buttons can lose their specific shape – and be reshaped using diamond cutting shoes and bit grinding tools. This procedure is often more ap-

appropriate to large expensive drill bits required to drill at high performance.

3.9.4 Hammer stripping

It is inevitable that the hammer will stop working one day or another. A drill crew, therefore, should have the tools and skills to strip the hammer clean and inspect and reassemble it in the field. In many cases the hammer will stop functioning because the piston is slightly stuck. The hammer body is threaded together and manufactured from hardened steel and in use can become very tight. Strong tools are required to grip the cylinder and hammer ends. Many hammers have large spanner flats that can be held with purpose made flame cut steel spanners to unthread. Conventional stilsons and chain wrenches are of limited use because they cannot bite teeth into the hardened steel hammer components to give a strong grip. To hold the cylinder clamps or clamping type spanners are required. The spanners and clamps to unthread are best arranged to give the threaded joint a jar with a blow from a sledge hammer rather than just a steady pull.

Alternatively, a hammer is best unthreaded while it is still able to work. Hammering the unit – turning on the compressed air with the hammer under the rig rotary head with the drill bit placed onto a piece of thick hardwood with no rotation or even reverse rotation – will shock and loosen the threads to allow the hammer to come apart easily.

Remember in which order the few components are stripped and the exact position they were assembled, re-assemble with the components clean, oiled and sliding freely.

A hammer will wear – most manufactures include with their operating instructions acceptable wear rates, say between piston and cylinders, and some hammer models have features of replaceable pistons and cylinder liners. Operated in a clean environment a hammer used on water-well construction should last a year or two at least before its performance drops off markedly. In general they have been perfected for near continual work in the harsh competitive environment of rock-quarry production-drilling in hard rock at ultimate performance, and in most case serve a lower production water-well operation with ease.

3.10 Precautions with other parts of the drilling operation

There are precautions to be taken when using a hammer. These particularly concern operation on small drilling equipment, but are of concern to any drilling operation.

The large percussive force, which is generated by the hammer piston being thrown on to the percussion button bit, that breaks rock so effectively will be transmitted in part up the drill-pipe, putting stresses and strains on components. Welded joints will suffer most because the welding process in particular often affects the material condition of the steel, creating stress points that could lead to failure/breakage during drilling. Evidence of this 'kinetic' energy will often be seen on the rotary head components, with threaded bolts and screws loosening. Equipment continually used with down-the-hole hammers will need specific servicing and replacement of parts to ensure continued serviceability.

Particular recommendations for a down-the-hole hammer operation

3.10.1 Shock absorbers

Use in-hole shock absorbers mounted directly above the hammer to reduce some of the shock passing up the drill pipe into the rig components.

Appropriate drill pipes

Use drill pipes engineered for the job. Any joints between lightweight body tube and threaded 'tool joints' should be designed and specified with consideration given to the effects of heat generated during the welding process, which affects basic material strengths and properties, together with the effect of alloying (mixing) dissimilar steels and the mechanical stresses involved.

3.10.2 Correct adaptors

Threaded adaptors used to join the hammer to drill-pipe or drill-pipe to rotary head should be machined as a single component from a strong grade of carbon steel. Avoid repairing or making up connections by welding.

3.11 Energy Efficiency

On working out a few examples of various compressed air requirements for specific diameter holes, it will be seen that appreciably high volumes of air can be required (see table 3.1). Compressed air is notoriously inefficient to produce, taking about 1 kw to produce 2 litre/second. Consequently, unless hole diameters are limited to an absolute minimum, the air compressor can dominate a drilling equipment package in terms of cost, size and technological content.

3.12 Difficult drilling - 'boulders'

The hardest ground formation faced by the rotary driller figure 3.4 & 3.5 - particularly with limited

power - is terrain at the base of substantial mountains with a formation consisting of a matrix of large rounded boulders interfilled with loose fine material. The individual boulders - upwards of 100 mm to several metres in diameter well rounded from being tumbled down a mountain and individually hard.

A drag blade will cut and move the small soft interfill and can wash clear pebbles up to 30/50mm diameter, but the cutting edge will not penetrate or cut the larger boulders - by placing weight on the drill bit the boulder will be pushed into the soft matrix of surrounding material. Fluid or foam drilling offer no solution.

A down-the-hole hammer will easily smash the boulders but the compressed air jet exhausting from the hammer will blow out the soft interfilled

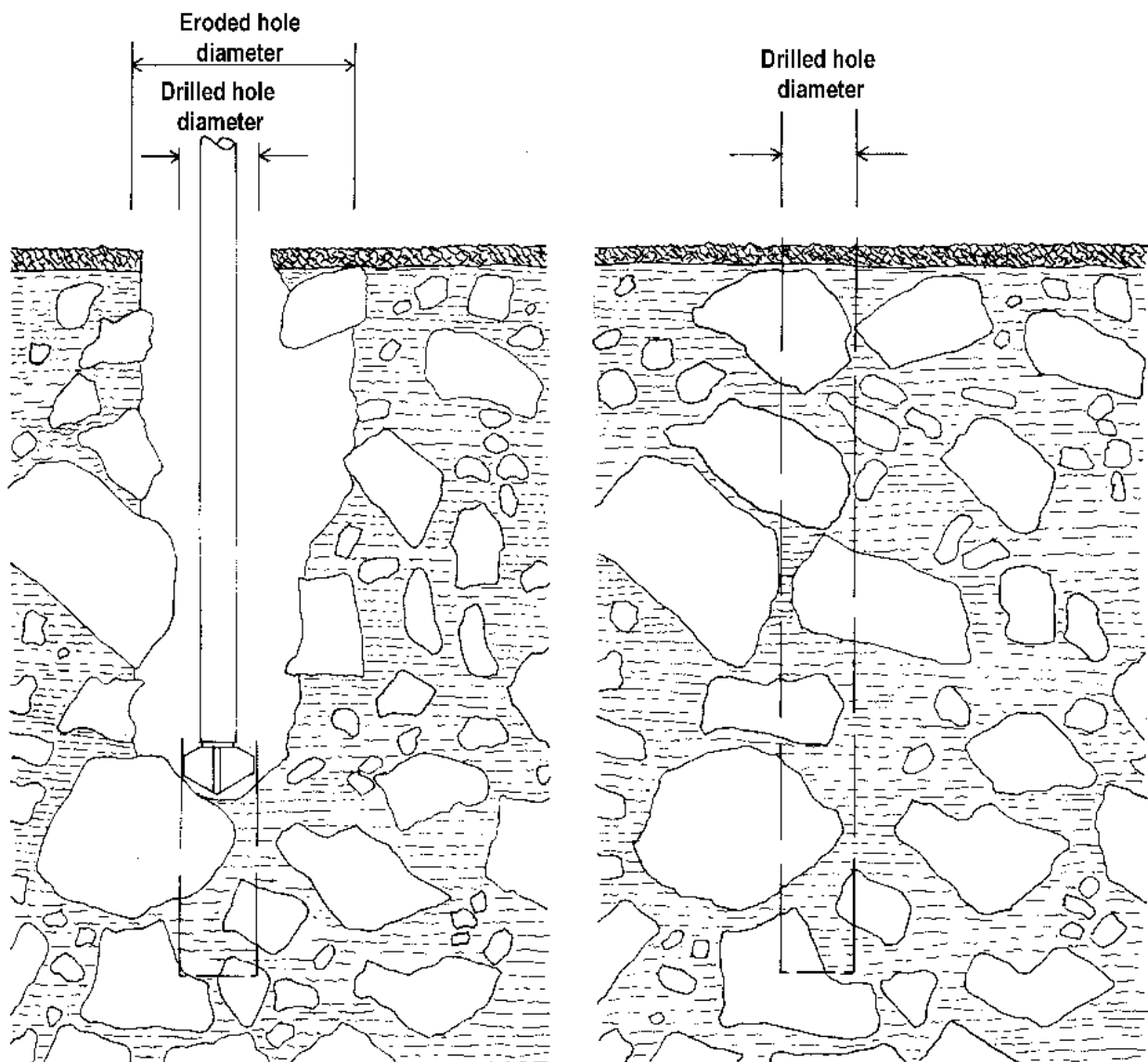

Figure 3.4 Difficulties of drilling boulder-filled ground

material. A potentially worse situation could be that the hammer bit will smash and pass through a boulder and the cracked piece will collapse and fall in behind the drill bit, with potential to wedge the hammer bit.

3.12.1 Solutions

Foam injection can stabilise the softer material and allow a hammer to pass through and make a hole stable enough to allow casing to be inserted. The hammer should be backed out (lifted up) regularly to keep the hole well flushed – maybe cutting back the airflow to prevent high degree of erosion.

An open matrix of boulders or a partially drilled hole can be cement filled – cement will flow into the gaps and, when hardened, will hold the formation to allow it to be penetrated more easily with a down-the-hole hammer. This operation might have to be repeated several times to penetrate a considerable depth of material.

The accepted method of dealing best with this difficult formation is to use a simultaneous casing system – supplied by most down-the-hammer manufactures. This allows steel casing, with threaded or welded joints, to be dragged or pushed directly behind the hammer to shield the walls from collapse. The hammer is fitted with a special oversized bit that has a hinged part that swings out to drill oversize and is able to swing in to allow it to

be retrieved up inside the placed casing. To use this method a rig should have a mast strong enough to handle the weight of the casing and long enough to handle useful lengths of casing – supported with additional power to push and rotate.

Other specialist tools such as reverse-circulation hammers might apply – these allow debris to flush up the centre of a dual-skin drill pipe. This will not erode the fragile hole walls – but requires expensive and heavy double-wall drill pipe.



Figure 3.5 Boulder-filled formation

4. *Drilling with foam*

Drilling with 'foam' combined with compressed air is used in different ways to help the drilling process. It involves using small-capacity pumps to inject a 'foam' mix at quite low flow rates into the compressed air supply line to make soap bubbles form in the borehole (Figure 4.1).

4.1 *High velocity foam – air misting*

When drilling consolidated rock with compressed air, clouds of dust can be blown out of the hole. Pumping a trickle of water into the airline will very effectively dampen the dust cloud, protecting both the health of operators and the equipment. Adding a soap solution (0.5 – 1.5% dilution) helps keep the hole walls clean and prevents small water-bearing fissures being clogged up and damp collars of drill cuttings forming above the drilling action. Typically, soap solutions used are biodegradable surfactants: they can be bought as specialist drilling additives or, conveniently and cheaply, as plain quality liquid dish-washing detergents or cold-water-mix laundry washing powder. Using foam, it is possible to drill successfully at lower up-hole air velocities because the foam keeps the hole cleaner and the bubbles help lift material clear at lower speeds.

4.2 *Low velocity foam – stable foam column*

By steadily injecting a mix of polymer drill mud (35-40 Marsh funnel seconds) and drill foam (0.5–1.5% dilution) into a flow-controlled air supply, it is possible to create a slow-rising column of stable foam, which lifts material out of the hole. It does not erode the formation and uses very little air, therefore allowing large diameter holes to be drilled in soft formations with small compressors. The effect to be created in the hole is a continuous mixed column of rising foam bubbles – similar in consistency to that of aerosol shaving foam. The foam will

'mushroom' in waves out of the top of the hole, carrying the drilling debris from the drill bit. If too much air is mixed with too little foam flow, little foam will erupt and the column will be broken by pockets of air. Good stable foam, if scooped between a pair of hands will lay quite thick and prevent the hand palms from touching easily. It will form a mass of soap bubbles with a definite body to it. The foam texture will change after water is laying in the hole – the bubble structure often gets larger with more dilution.

It is an impressive technique to apply to constructing a hole in the ground using very little compressed air and a small volume of water. It should be seen to be believed and time should be allowed for inexperienced drill crews to get confident in its application.

4.3 *Poor hole stability and a very messy operation*

Unfortunately for the water-well driller, this 'slow foam' does not offer any 'hydrostatic' support to prevent holes in soft formation from collapsing inwards – particularly because the most common reason for collapse is the presence of ground water. Such formations are better drilled with circulation



Figure 4.1 *Drilling with stable foam*

fluid, when a hydrostatic head will prevent hole collapse.

It is hard, but not totally impossible, to collect a good set of representative samples as the borehole debris is carried and hidden in an expanding blanket of foam around the rig site. If left unchecked it will literally blanket the entire drill site, hiding sound footing and any tooling and hoses left on the ground. A certain amount can be done to channel the foam blanket away from the rig by creating plywood or similar flow channels. Sunlight and time effectively breaks down the bubbles. In high wind the foam can blow around and spread its mess a considerable distance – after the foam has broken an even blanket of debris will be left as testament to the foam’s ability to carry and hold material. It is not a method for an environmentally challenged site.

4.4 *Non-return valve sub adapter*

When drilling with ‘slow foam’ under the water rest level of a borehole, where water is lying it is essential to fit a ‘non-return valve sub adaptor’ above the drill bit. This will allow the foam mixture through to the drill bit but will not allow flow back up the drill pipe. This valve will prevent the resting water and debris at the base of the borehole to flood back inside the drill bit and drill pipe when the air and foam mix is stopped – for instance to add on another drill pipe. If debris does flow back into the drill pipe it is very likely to block the downward flow in the restricted bore of the drill pipe once air and foam mix is started again.

4.5 *Where can it be used?*

It is a very useful method to drill a larger diameter than the air compressor capacity could drill directly, for instance to set and seal surface casing. It can also be used to drill a complete well in a soft rock formation that is stable from collapse because little fluid pressure is exerted on the borehole sides and very little invasion of the water-bearing permeable layer will occur. It might be sensible to have piloted a small-diameter hole to depth with air or water to collect samples and log the formation, and then use foam drilling to ream out the final hole diameter.

4.6 *Well dippers*

Well dippers fitted with sensitivity controls can be set to detect the rest-level of foam in a hole and alternatively set to detect the water column that might be underlying the foam layer. Without this sensitivity control, beware that any water-level readings might be misleading if the dipper is signalling the presence of a foam column rather than a water rest level.

4.7 *Foam pump types*

Many types of pump are suitable for use for foam injection purposes. The basic requirement is the ability to pump a slightly viscous, but clean, fluid up to the maximum pressure of the air compressor (nominally above 6 bar [100 psi]) at relatively low delivery volumes (1–20 litres/minute [.25 - 4 gallons/

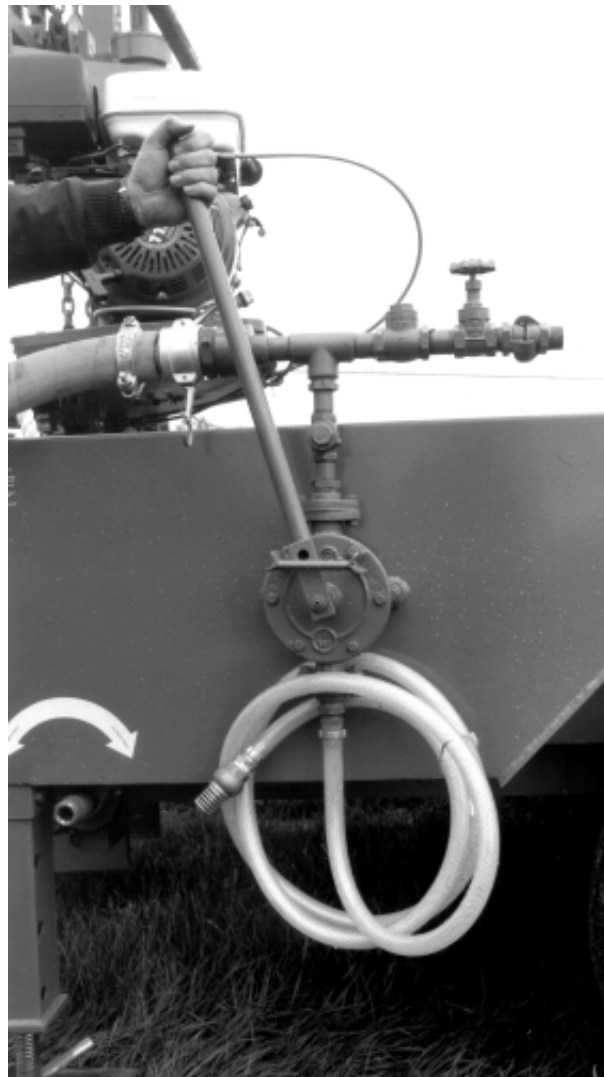

Figure 4.2 *Semi rotary hand pump*

minute)). This will meet most foam drilling requirements. The following types of pump can be used:

4.7.1 Hand Pump

Semi rotary or piston 'pressure testing' pump; (figure 4.2)

4.7.2 Barrel Type Pump

Air- or electric-powered typical product transfer pumps designed to work from standard 200-litre (45 gallon) drum;

4.7.3 Piston Pumps

Duplex or triplex high-pressure pumps – typically 'water-pressure wash' duties. These are readily available as electric-, petrol-, or diesel-powered.

The most significant attribute of any foam pump is being able to control the injection flow rate to just the minimum required – over-injecting does not often cause many problems other than wasting water and making more mess on the surface. In remote locations, where water is being carried long distances, it helps to conserve its use to the bare essentials.

4.8 Foam inlet manifold

A simple pipe manifold (figure 4.3) is required to allow injection of foam – standard fittings as found in most plumbers can be used. Both the foam pump and the compressor require protection from being back-filled with each other's medium by fitting non-return valves. For low-velocity foam a suitable gate valve fitted to the air supply helps regulate the air-flow to give the correct air/foam mix.

4.9 Mixing method

In both foam drilling methods a good mixing method is to use two, or possibly even three, 200-litre (45-gallon) open-topped barrels. In each drum mix the required foam formula, first mixing the polymer (only for slow foam) arriving at a convenient volumetric addition for the required viscosity, 35–40 Marsh funnel seconds (i.e. – 1 litre jug of polymer powder = 40 sec mix in 200 litres of water). Allow time for this mixture to yield viscosity. Add the foam .5 to no more than 1.5% dilution i.e. 1-3 litres of liquid soap or drill foam to a 200-litre barrel at the last minute, using just a few stirs with a clean spade or shovel to mix. Use water as clean as possible to mix to prevent fines and dirt from damaging or

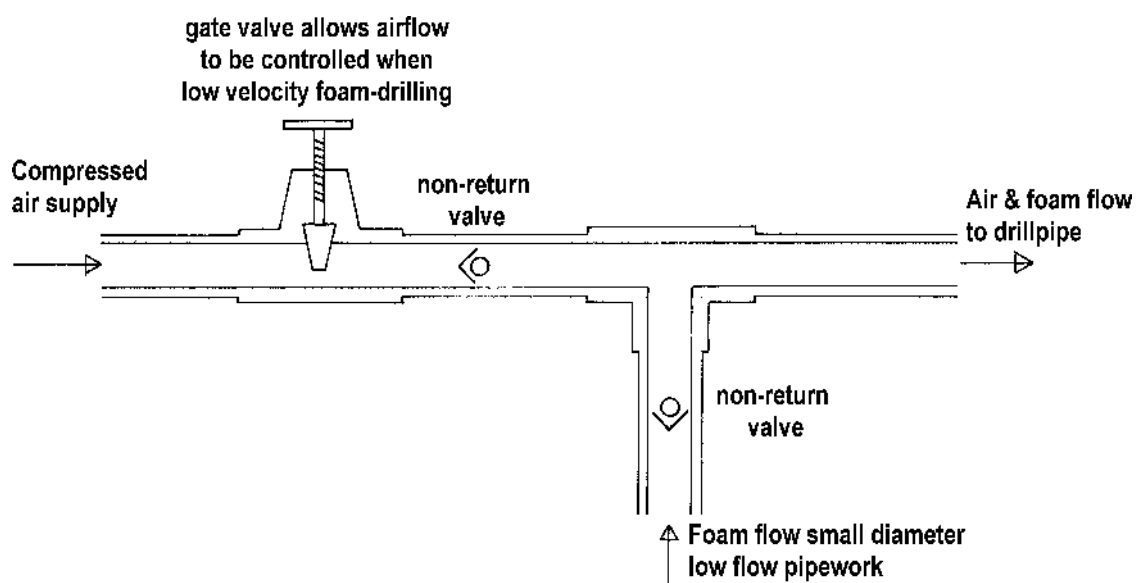

Figure 4.3 Typical foam injection manifold

blocking suction-line filters of the small parts and passages of the foam pump.

4.10 Adequate foam supply

Use the first barrel until empty and then switch the foam pump suction to the second barrel. While using this barrel, re-mix the first barrel. In this way, it will be possible to have a continuous foam supply available to the drilling operation. High foam consumption might dictate introducing a third barrel into the system to ensure that a mixed barrel of fully "yielded" polymer is always available.

5. *Logging of samples*

5.1 *Introduction*

The water-well driller needs to identify and report accurately the ground formation he is drilling in because screen and or casing will have to be set at depths where favourable aquifer material has been logged. The log is key information that the driller requires to make these essential construction decisions.

5.2 *Fluid drilled holes*

In a fluid-drilled hole a driller can be absolutely sure there is water present in the strata only when a hole is completed. Sieving the water/fluid as it flows from the top of a hole collects samples. As the ascending speed is quite slow and debris is continually



Figure 5.1 *1m samples laid out for view*

dropping by gravity in the ascending flow, it can take several minutes for material to exit from a hole after it has been drilled. A driller should be aware of this time delay, which increases as pump flows get restricted and boreholes are deepened. The first and most reliable sign of a formation change is felt by the driller in control of the drill bit, who will sense a different drill bit pressure and rotation power as different ground formations are met. Formations with gravel or stones invariably make a drilling machine shake and rattle – hydraulic gauges connected to the rotation motors will flicker. Sands require low power to rotate the drill bits and very little weight on the bit to make it sink into the ground. Clay requires more power to rotate and push the drill bit. Observant drillers can be encouraged to learn to read the signs of a particular machine in order to become confident about what sort of geological material is being drilled.

The driller should note the exact depths of these changes and then check over the next few minutes with the person sampling that indeed a formation change has taken place.

5.3 *Drilling with compressed air*

When drilling with compressed air, it takes just seconds for material cut by the drill bit to be blown clear at the surface, making it easy for accurate logging of the formation being drilled. It is also easy to see when water is present because this is also blown clear. By channelling this water through a horizontal pipe – an off-cut of casing set in a shallow dike of shovelled soil - it is possible to estimate flow by timing the seconds it takes to fill a small bucket and, as drilling continues, to check whether the flow is being improved. It is important to 'chalk' the drill-pipe to constantly be aware of drill bit depth (see page 30). Logging the depth of water strikes is more important than the collection of samples of the rock being drilled.

5.4 Sample collection

Collected samples, whether drilled by fluid or compressed air, should be laid out on a cleaned, flattened area of the drill site, convenient plank, sacking or board or an open sample box clearly marked with the depth they have come from (Figure 5.1). It is a good idea to keep the samples fully in sight and accessible during the drilling operation so that constant comparisons of colour, consistency and material type can be made. A balanced practical judgement of where best to screen and case a hole can then be made easily and quickly.

5.5 'Chalking' the drill pipe

To log properly, the driller needs to know the exact depth of the drill bit at any given moment. This is best achieved by 'chalking' the drill-pipe. With the drilling rig set up with the first length of drill-pipe and drill bit fitted, the drill bit should be lowered to ground level. Mark the drill-pipe '0' at a convenient adjacent visual point – for example, at the table that centralises the drill-pipe – and then make chalk marks at 0.5 metre intervals up the drill-pipe, numbering the marks from 0 upwards. Measured chalk marks can be made on subsequent drill pipes to be added. If this procedure is followed, the driller or indeed anyone on the drill crew will know at a glance the exact depth of the drill bit from the ground surface (Figures 5.2 & 5.3).

5.6 Writing up of a log

Most organised drilling programmes settle on the production of a borehole log, being a pro-forma type form used to record the details of a hole drilled. With good fortune these are collated, copied and filed, and become a useful resource when planning further drilling operations or well-rehabilitation programmes. The key is accuracy and consistency, deciding on the minimum critical information required to record accurately. For perpetuity the information about depth to water table, well yield and materials used to line the well are more important than the details of how the hole was constructed.

From the drillers perspective, the person who is busy with the equipment on a daily basis the preparation

of detailed logs can be very time consuming. Insufficient time is often allocated to this task because it is seen as 'non-production'.

At very least the driller or one of the drill crew should be encouraged to scribble notes in a rough note book to record the essential data securely. Having obtained a sound record of data attention can be given later to how it finally gets presented as a borehole log, perhaps by using staff other than the driller.

There is also considerable value in involving the local community in showing and explaining how the borehole has been constructed. Often written logs are not available and there is only a voice in a crowd giving his or her best explanation of what he or she saw years before when a hole was drilled.

5.7 Getting it right

The importance of undertaking proper logging and measurement of hole depth cannot be overstated. Accurate logging can be the difference between a well that produces water and one that does not.

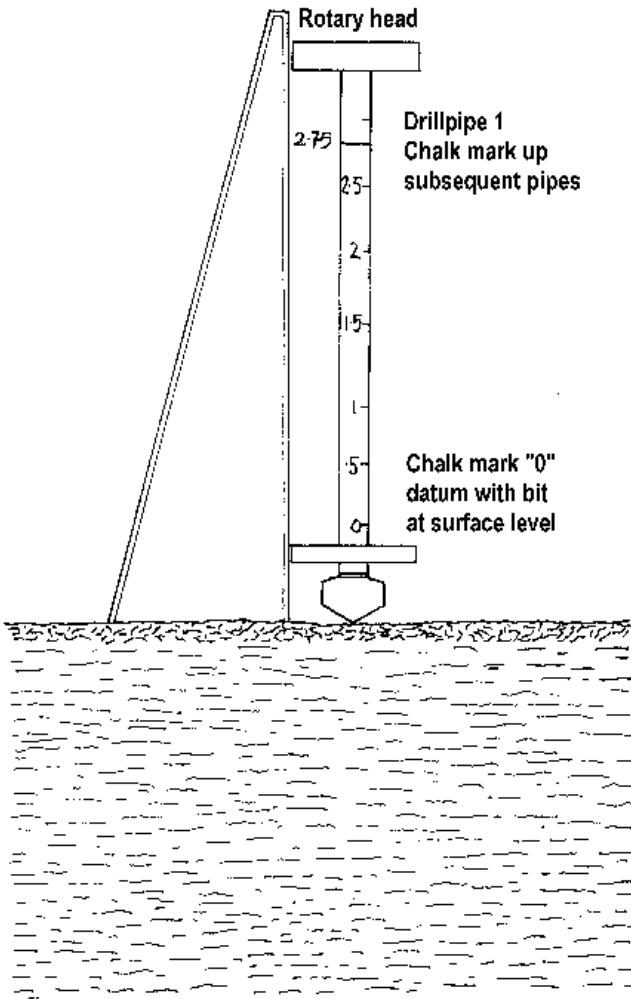
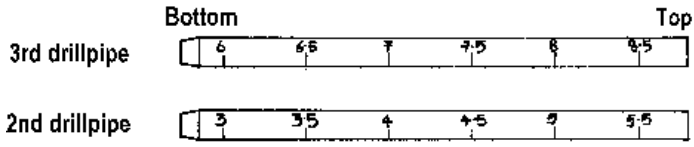

Figure 5.2 Chalking pipe at datum

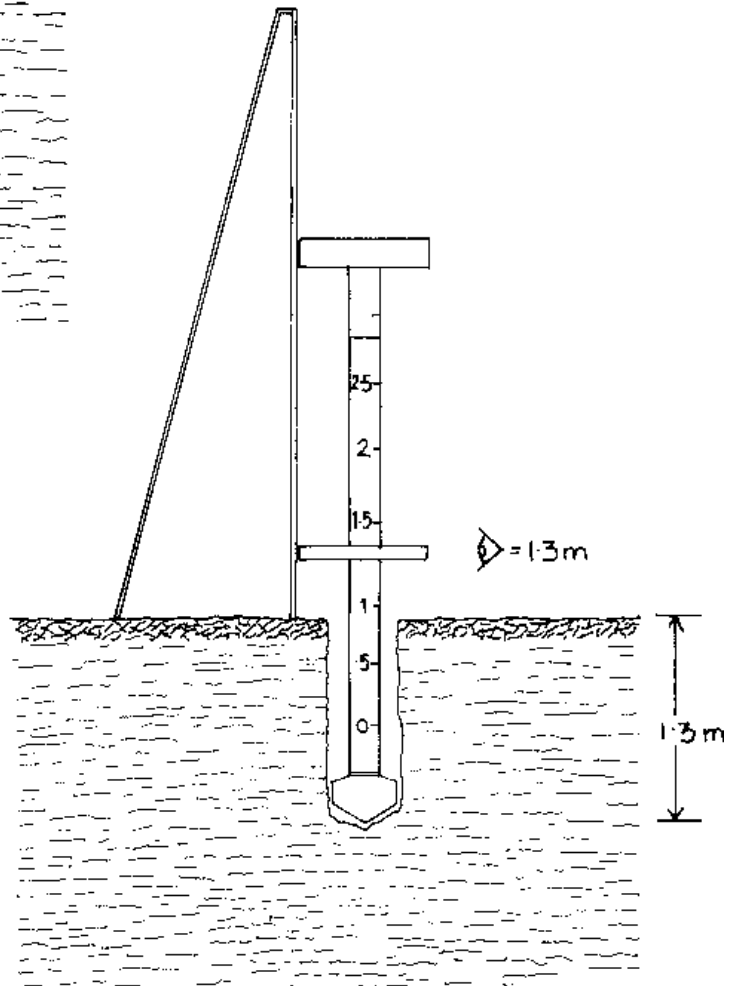

Figure 5.3 Chalking pipe at 1.3m depth

6. Borehole design

The key to borehole design is to arrive at a solution to pumping or lifting the water from the proposed well. To do this successfully it is essential to understand and take into account the nature of the geology underlying the surface, which will dictate the amount and depth of the water supply.

6.1 Hand pumps

There are hundreds of designs and solutions to lifting water from wells using the human body as an engine. They are all limited in the volume of water they produce by the power capacity of the human being. Boreholes designed for hand pumps, therefore, should cater only for relatively small flows and address properly the size of community they serve. A typical hand pump capable of delivering a

theoretical 1500 litres an hour is probably only good enough to serve a maximum population of 300 people. A hand pump fully utilised without a break throughout an hour working to full capacity might in theory achieve 1500/litres/hour – in practice even with a well organised 'line up' of water collectors working constantly and taking the minimum of time they will struggle to pump out more than 700 litres per hour into water containers.

6.1.1 Sustainability

Probably the single biggest factor of hand pump choice is the ability for it to be operated, maintained and repaired by people in the community served by the pump. After this social assessment, the engineering considerations of the water depth and well diameter can be examined.

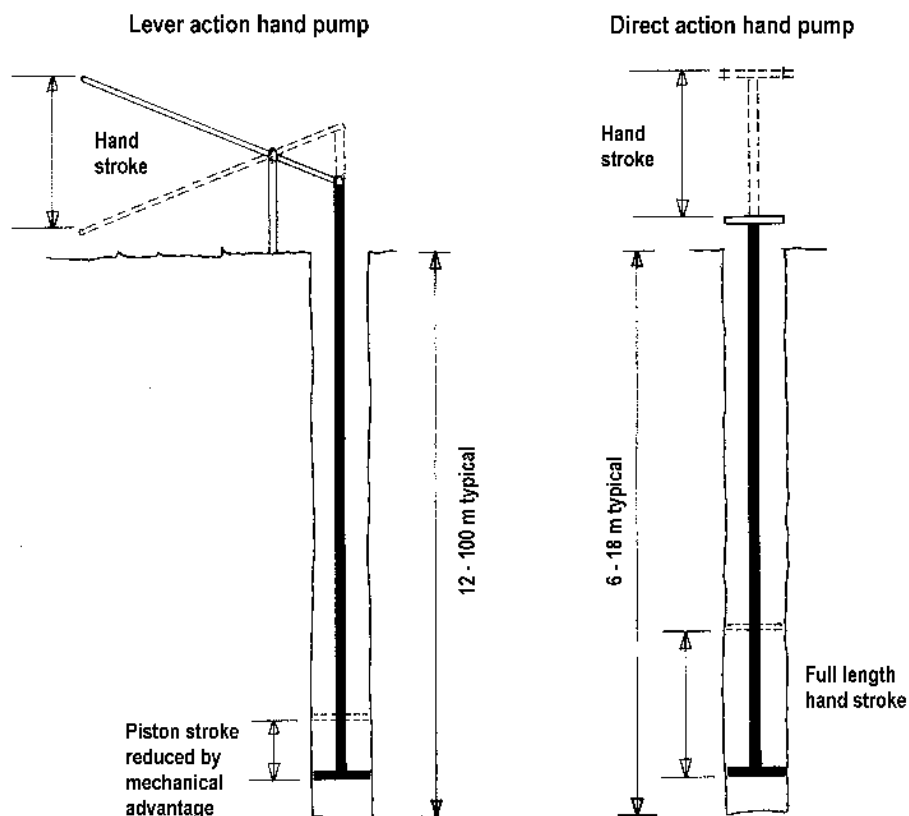

Figure 6.1 Lever Action Hand Pump / Direct Action Hand Pump



Figure 6.2 *Direct Acting hand pump*

Typically, reciprocating piston pumps are common, with 'levered' mechanical advantage designs being used for lifting water over 18 metres and 'direct acting' (Figure 6.1 & 6.2) designs being suitable for lifting water up to 18 metres. As well as many purely commercial, private-enterprise products on the world market, there are a number of 'public domain' design units that are both commercially available with universal /interchangeable parts and as detailed specifications for 'local' manufacture.

6.2 *Electric Submersible pumps*

If electric power is available, a submersible pump is an easy cost-effective solution (an electric submersible pump costs less than a typical hand pump). For small wells a 4" submersible pump can be fitted inside a 4" well casing and can deliver 300–12,000 litres/hour with a motor ranging from 0.25 to 3.7 kW. Submersible pumps can be lowered into wells on flexible pipes and be fitted with pressure-controlled on/off systems and automatic depth cut-out devices.

Electric submersible pumps are probably the most adaptable of pumps for groundwater abstraction. Being an impeller type pump, their water flow is greatly affected by the pressure head it pumps to – this pressure head can be influenced by the depth the pump is set in the well and, additionally, by any delivery head above the well head, or induced by a valve to depress the volume delivered. Where water is difficult to find in quantity it is possible to use small electric submersibles pumping tiny volumes of maybe as little 200 litres/hour into a central storage or distribution network. When joined with other wells drilled in an adjacent well field it is possible to begin to abstract some quite large daily volumes. This relies on the ready availability of electric power.

6.2.1 *Installation depth*

An electric submersible pump, along with most pumps, should always be fitted above the screened portion or water intake of a borehole, so that the water entering the pump flows across the motor, constantly cooling it. It is therefore important that the pump should be matched to the borehole casing to ensure adequate velocity of the cooling flow. (Figure 6.3 & 6.4)

6.2.2 *Diameter of installation*

A typical 4" electric submersible pump is designed to work inside 4" diameter well casing. The casing with a bore of 103 mm fitted with a pump of 96 mm will induce a water velocity over the pump motor equal to the water velocity pumping water to surface in typically a 32 mm (1 1/4") rising main.

6.3 *Spindle-driven pumps*

Spindle-driven pumps can be belt-driven by a surface engine of any description and can be turned at varying speeds to achieve flows of 300–12,000 litres/hour from a pump element inserted in a 4"-diameter well casing. For small wells, these pumps are usually 'progressive cavity type pumps' consisting of a helical screw rotating in a rubber stator. While being more complicated to install and more expensive to purchase than an electric submersible pump, because they require installation on rigid pipe

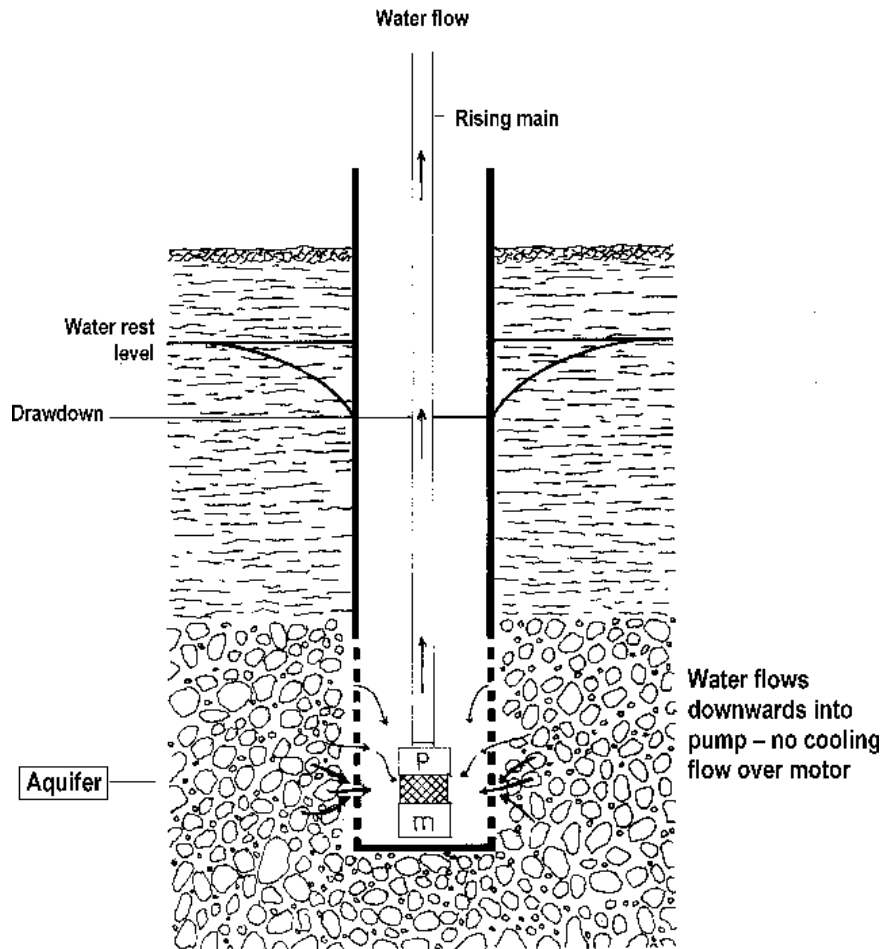

Figure 6.3 Incorrect installation of electric submersible pump

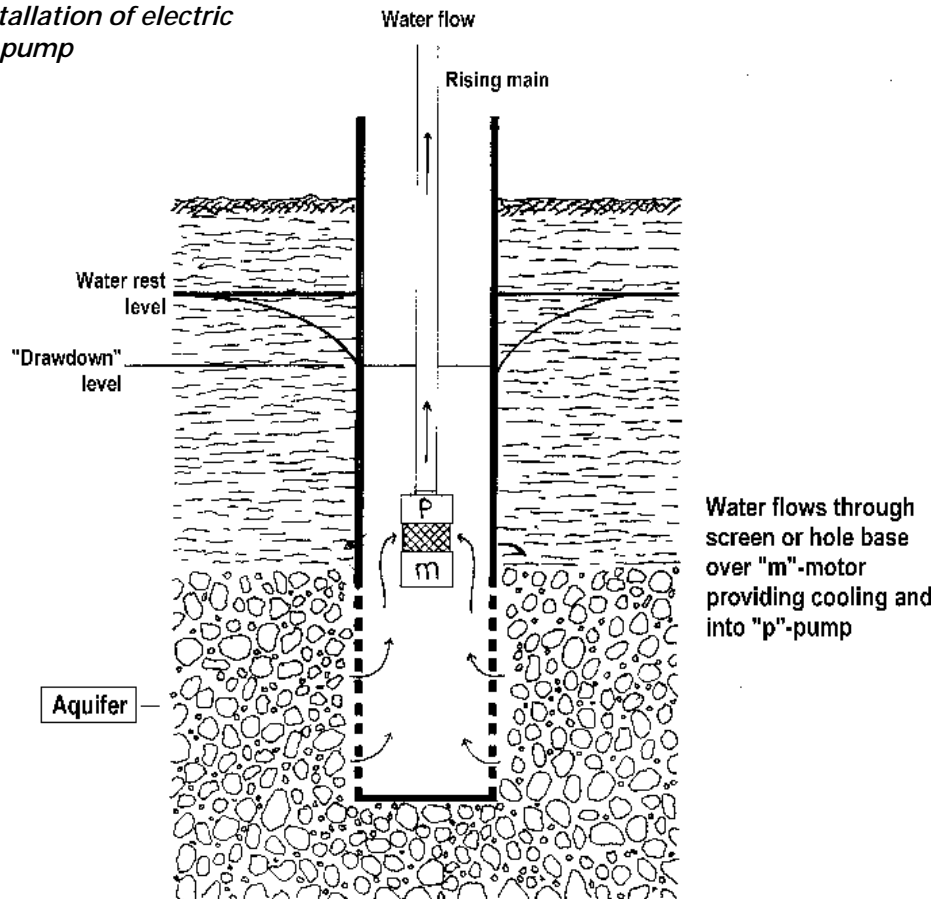

Figure 6.4 Correct installation of electric submersible pump

work with an internal drive shaft, they have the advantage of rotating more slowly and are considerably more sand tolerant. They also can be employed in situations with suctions below a well screen or water intake section of a well.

6.4 Suction pumps

If the ground-water table is less than 6–7 metres below the ground surface, it is possible to ‘suck’ water into a surface-mounted ‘self priming’ centrifugal

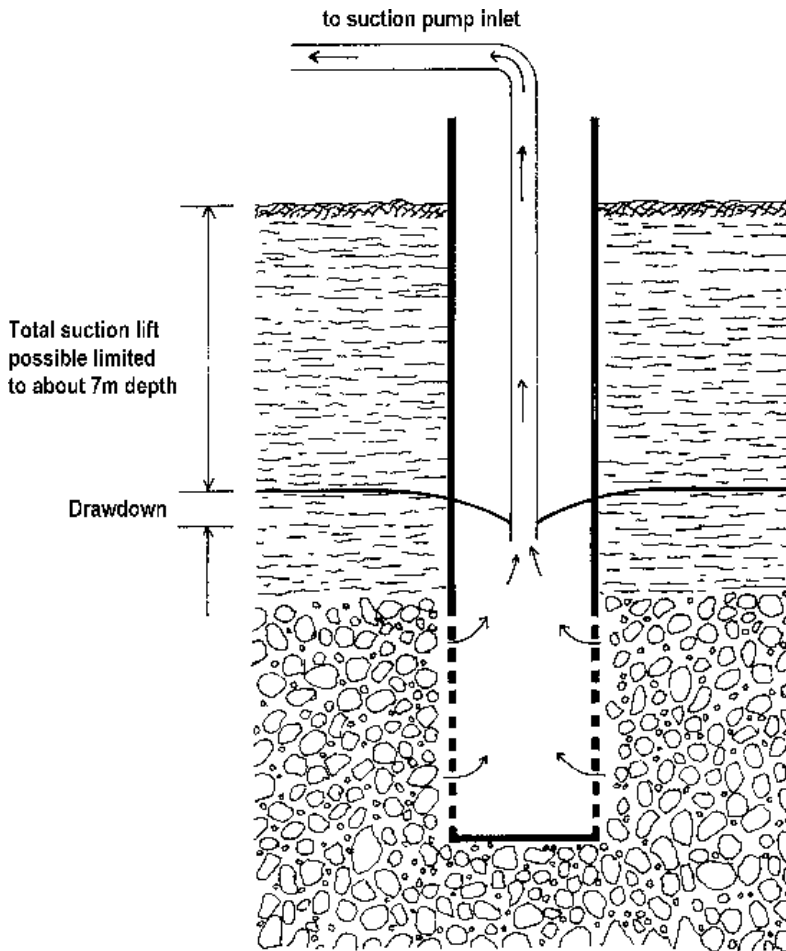

Figure 6.5 Suction pump installation



Figure 6.6 Centrifugal pump drawing water from a 100mm (4") tubewell

gal pump, (depending on pump efficiency and well altitude). Almost any engine can power these suction pumps, (figure 6.5 & 6.6) but they are very commonly available mass-produced with small Japanese petrol or diesel engines. The volume of water obtainable is very variable, but flows of 10,000–40,000 litres per hour are quite achievable in a productive water-bearing aquifer. Sometimes a pit can be dug to lower the pump to within suction 'reach' of the water table.

6.5 Hydrogeology

The nature of the underlying geology and its connection to rainwater run-off will dictate what water is available for pumping from a well. Very broadly, the well-driller looks at the following groups for water supply.

6.5.1 Catchment area

A borehole has to be sited and drilled to a depth below a catchment-watershed. This is the level below which rainwater and consequent stream and river run-off has soaked into a porous underground formation. By carefully studying the area and geology of a water catchment and measuring the rainfall, experts can determine just how much groundwater

is being stored and where. A driller left to his or her own devices should avoid drilling on top of granite mountains and take time to think about where he or she hopes the water is coming from.

6.5.2 Well-sorted sedimentary deposits

Well-sorted sedimentary deposits are sands or gravel's that are quite coarse and contain very high volumes of water in a very porous formation. They are easy to drill, provided that a 3 metre plus drill fluid head can maintain hole stability (Figure 6.7).

6.5.3 Poorly sorted sedimentary deposit

These differ from well-sorted sedimentary deposits by having finer grains intermingled with the coarser material, reducing water storage and porosity of the formation. They are easy to drill with drill fluid, but it may take some guesswork to commit well screen and develop the hole to prove that water is available and at what volume.

6.5.4 Porous rock

Limestones that have fissures widened by the chemical action of the ground-water can be found in very thick layers containing large quantities of

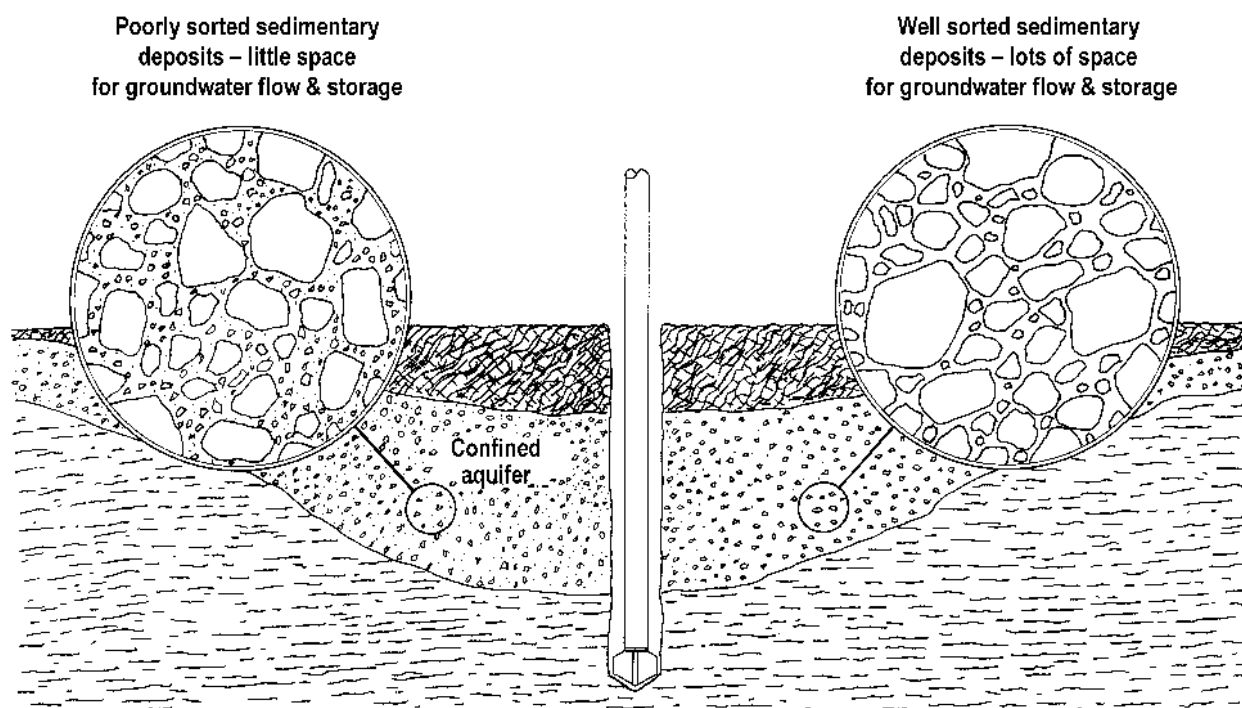

Figure 6.7 Sedimentary formation

water. Generally they are easy to drill with an air compressor and down-the-hole hammer, and water is generally reliably found in large quantities.

6.5.5 Fractured rock

In this type of formation, water flows through the weathered mantle lying above the fresh rock and is stored in parts of the weathered mantle and fractures in the rock structure. The key to drilling is to locate a site likely to intersect a fractured zone. This takes either skilled siting by hydrogeologists, or faith in water divining, and the resolve to accept the drilling of experimental dry holes (Figure 6.8).

6.5.6 Confined and unconfined aquifers

A confined aquifer will be overlain by an impermeable layer – clay, silt or consolidated rock – above the aquifer. There are circumstances where the confining layer is at a lower elevation than the water table, resulting in an ‘artesian’ effect. Where the confining layer is in a natural basin, it is possible that the water might flow out of the well at the ground surface – becoming a flowing artesian well. Wherever possible, such a situation should be anticipated so that surface casing can be firmly grouted into the permeable layer so that the artesian pressure can be controlled. Artesian pressure

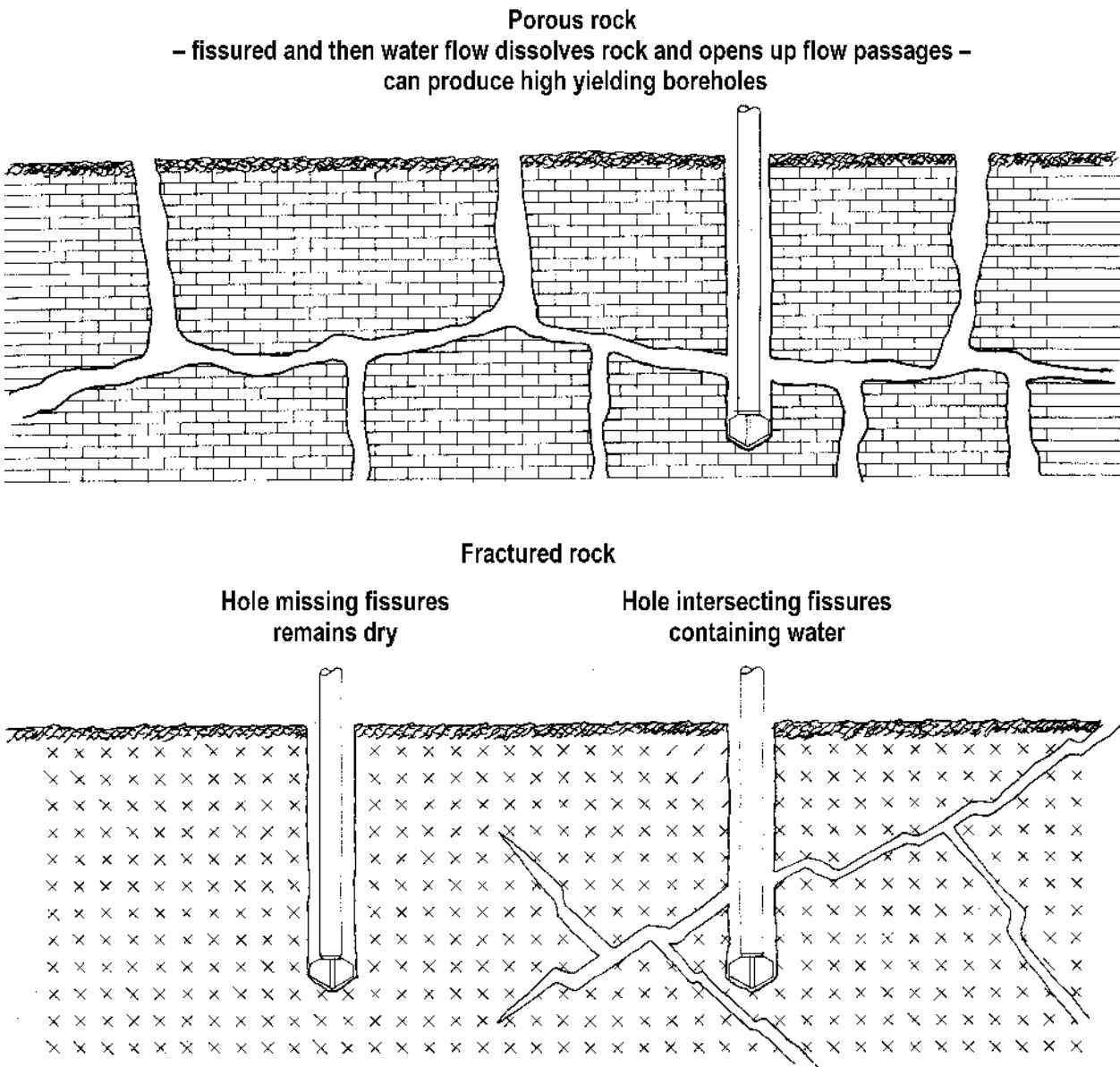

Figure 6.8 Rock types

might also require special fluid control to ensure maintenance of a hydrostatic head to keep soft formations from collapse.

An unconfined aquifer will find its own level in permeable material.

6.6 Borehole siting near latrines

Consideration should be given to the catchment area and the nature of the geology regarding the siting of a clean water source close to potential contamination from dug latrine pits or other liquid waste disposal facilities. Common-sense dictates that distance is advisable – however, where both sanitation and clean water are required close to where people live it, is difficult to avoid drilling near potential sources of pollution.

Distance is important but consideration of the flow of the water might be more important – to site ‘up slope’ from a latrine is better than being ‘down slope’. Deeper aquifers confined by impermeable layers are at less risk than shallow unconfined aquifers. Water supplies from fissured supplies have the potential of pollution travelling a further distance than in, say, a bed of fine sand.

6.7 Well-lining materials

Having constructed a hole, a water well is often completed with the installation of some materials before a pump is inserted.

6.7.1 Well casing

Traditionally, steel pipe was used for lining wells but plastics have now universally replaced the use of steel pipe in shallow wells, say drilled less than 200m deep. Plastic piping is mass-produced worldwide for all kinds of uses and is generally borrowed from one of the large-consuming uses for well casing. Thick-walled pipe (over 5 mm) can be threaded to produce flush coupled joints. Alternatively, pipe can be joined by slip sockets that are glued on assembly. The choice of material will depend on market availability, cost, and possibly well-depth requiring a thicker wall pipe.

It is this use of plastic well-lining that has made it possible to drill with smaller and smaller drilling machines – before the use of plastic a substantial drilling machine would be required to handle the weight of the final well lining – use of plastic has made the final lining weight virtually insignificant in comparison.

6.7.2 uPVC pipe

The diameter of the pipe is crucial, with the outside diameter determined by the ‘dies’ available to the pipe extruder. The wall thickness can be variable. Well drillers worry less about the outside diameter of a pipe than the inside, into which they are required to insert a drill bit or borehole pump. There are two main ‘international’ conventions of sizes: metric-based and inch-based, each separated often by just a few millimetres (see Table 6.1). However, those few millimetres have practical consequences for the well driller. Typically, a 110-mm OD (outside diameter) metric pipe might be sold colloquially as ‘4’-well casing’, but with a 6 mm wall the bore will actually be too small to accept the insertion of a 4” electric submersible pump (typically 96/97 mm diameter).

Nominal inch size	METRIC		ENGLISH	
	Outside Diameter	Approx Inside Diameter	Outside Diameter	Approx Inside Diameter
1.1/2"	40mm	33mm	48.1mm	40mm
2"	63mm	55mm	60.2mm	52mm
2.1/2"	75mm	65mm	75mm	65mm
3"	90mm	80mm	88.7mm	78mm
4"	110mm	98mm	114.1mm	102mm
5"	125mm	116mm	140mm	130mm
6"	160mm	148mm	168mm	154mm
8"	225mm	210mm	219mm	204mm

Table 6.1 Comparison between ‘Metric’ & ‘English’ uPVC pipe sizes

6.7.3 Well screen

The well screen will hold back sedimentary or soft aquifers while allowing water to filter into the well. For a well to perform correctly, the screen slot needs to be equal or less than the average grain size of the aquifer and of a sufficient length to allow water to enter the well at a maximum velocity of 0.03 metres/sec. (table 6.2 & 6.3) With

litres/hour	litres/minute	litres/second	gallons/hour	gallons/minute	Minimum screen opening cm^2
1000	17	0.3	220	4	100
1500	25	0.4	330	6	150
2000	33	0.6	440	7	200
3000	50	0.8	660	11	300
4000	67	1.1	880	15	400
5000	83	1.4	1100	18	500
7500	125	2.1	1650	28	750
10000	167	2.8	2200	37	1000
15000	250	4.2	3300	55	1500
20000	333	5.6	4400	73	2000
25000	417	7	5500	92	2500
30000	500	8.3	6600	110	3000
40000	667	11.1	8800	147	4000

This table has been calculated from the formula in Table 6.3 to derive the open area in cm^2 at a maximum inflow velocity of .03metres/sec. In practice more screen should be used than this minimum to allow for the many variables in nature of aquifer and screen placement.

Table 6.2 Minimum screen opening for a range of anticipated flows

By calculating the open area of screen available, it is possible to work out the length of screen required to obtain a required yield (assuming sufficient depth of permeable aquifer exists).

$$L \times W \times N \times 0.1 = \text{Open area of screen/metre of screen (cm}^2\text{)}$$

Where:

- L = length of slot (cm) - measure internal opening in bore of screen
- W = Width of slot (mm)
- N = Total number of slots per metre length

As a guide: 1 cm^2 of screen = minimum entrance velocity for 10 litres/h

Table 6.3 Formula to calculate screen open area

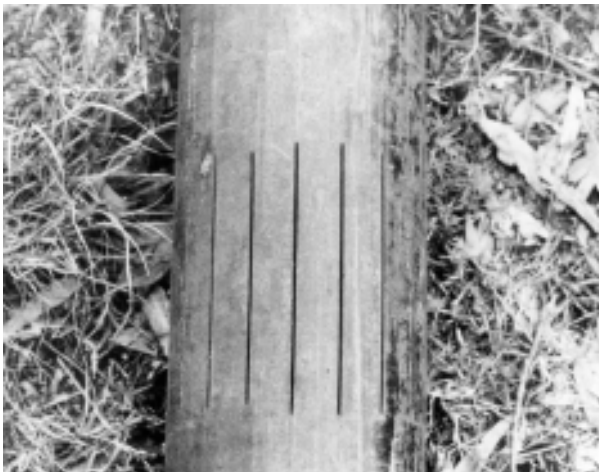

Figure 6.9 Steel Slotted pipe

the advent of plastics, the job of screening a well is much easier and plastic can be easily slit with purpose-made slitting saws (unlike steel casing) (figure 6.9) to create thousands of fine or coarse cuts in a standard length of well casing. Well screen can be procured from manufacturers or produced with a slotting machine by the driller.

The materials chosen for use in borehole construction are going to be constrained by the drilling method and the maximum diameter that the particular equipment will drill. The most important consideration should be to consider the pump intended for use in the borehole. The well casing should obviously be of sufficient diameter – just – to house the pump and any well screen should suit the anticipated pumping rate.

6.7.4 Polyester ‘Geotextile’ Stocking

Fine grained aquifers – that would require a very small slot cutting in the screen and consequently offer a low open area can utilise a polyester stocking pulled over a slotted screen – typically the cloth will filter below 10 microns and has proven very effective as a clear alternative to obligatory gravel packing.

The key is to use a generous slot size of 1 to 2mm and the accepted rule of thumb is that use of the stocking is to halve the basic screen open area.

Stocking can be supplied as a proprietary knitted stocking in 30+ metres length – simply cut to required length and pulled over the screen – fixed in place with fine string, wire or sticky tape. Alternatively any suitable synthetic – rot proof open weave cloth can be sewn into a cylinder and installed on a well screen.

6.7.5 Use of fine slot well screens

Special care is required when using well screen of less than .5mm slot – when inserting into a fluid filled hole. As the screen is lowered the fluid standing in the hole will push through the screen and if still viscous and containing small particles it can quickly block and jam into the slots greatly reducing the open area. When using fine slot screen it is advised to displace the drill fluid standing in the

hole with fresh clean water – ideally through the drill pipe as final hole depth is reached.

6.7.6 Telescopic casing & screen

Diameter used in a borehole can be mixed. A small diameter ‘string’ of casing and screen can be telescoped into a well through set surface casing and below any anticipated pump setting depth. This could be used in a hard rock hole where there might be a danger of the rock crumbling into the hole. In an unconsolidated formation the screen section can be of reduced diameter – this will create an annulus for gravel packing (Figure 6.10).

6.7.7 uPVC casing and storage

uPVC and, indeed, all plastic casing needs careful storage and transport. Avoid stacking/storing pipes in direct sunlight because plastic materials often degrade when exposed to sunlight, and keep stacks no more than four pipes high to prevent pipes being squashed. Also keep stacks in order and neat, keeping the pipe as straight as possible. Generally, in tropical countries be aware that heat will soften the plastic and make pipe liable to distortion. On the other hand, in cold countries with near sub-zero temperatures, uPVC in particular will become brittle and liable to crack if handled roughly.



Figure 6.10 Placement of telescopic screen using simple bayonet tool

7. *Well completion*

7.1 *Designing the well construction*

The previous chapters have helped define the choice of pumping method, well screen and casing diameter requirements and a method of making a hole in the ground. In order to decide on an appropriate final construction, the driller should consider a number of points. These are listed below. The checklist is based on a fluid-drilled hole, which presents more problems and unknowns to the driller than an air-drilled hole, where constant evaluation of water volume is possible during the drilling process.

7.2 *Volume*

How much water is required or expected? This is easy to calculate for a hand pump installation limited to, typically, below 1000 litres/hour but harder to evaluate on an irrigation tube well where any huge amount of water would be welcome. For the hand pump, the well design can be linked to the hand-pump yield required, thus limiting the intake area of the screen. For the irrigation well or maximum-production well, all the available aquifer should be screened unless experience dictates that less screen length is required for the necessary pump flow.

7.3 *Geology and Sampling*

Examine the borehole log and collected samples, choosing the material likely to yield most water and suitable for the screen opening available on site, matching its depth to the calculated required length of screen. The key to good construction lies in accurate sampling and formation logging. Ground water is stored and flows through the gaps left between the individual grains of a formation. The signs of a good, productive water-bearing layer would be the absence of very fine silty material and,

on very close examination, rounded one that is water-washed rather than with sharp corners. The natural water level can rise in a drilled well if impermeable layers have been drilled overlying the permeable layers.

Samples of potential aquifers should be examined very closely to match the correct screen slot size: a practical field guide is to take a sample on the tip of a finger and rub it against the screen slot – a perfect slot will allow some fine sand to pass and coarse grains to bridge. In theory, perfect screen slot should be sized to equal the average grain size of the water-bearing formation. Allowing the fine portion of the formation to be washed (developed) through the screen into the well will create a highly permeable natural filter around the well-screen, maximizing potential well yield. In practice, screen of smaller slot than the formation will produce clean water.

7.4 *Depth to water*

Discover the probable water-table depth. With a fluid-drilled hole kept full of liquid to maintain the 'hydrostatic head' this will not be known from the hole drilled. There is invariably some indicator locally of where the water table is likely to be: a dug well, river or clear geological division (beware of confined aquifers though).

7.5 *Pump insertion depth*

Consider your pump placement with likely drawdown if this to be housed above the screen. Therefore, a compromise might be required regarding screen length and its position in the hole. Drawdown is the distance measured between water rest – the water table and the dynamic or pumped water level measured when a pump is constantly pumping. This can vary hugely from just a few mm to several tens of

metres, and is normally dependent on the broad types of geology and terrain being drilled.

7.6 *Rough sketches*

During consideration of these points, sketch out a very rough borehole, indicating where the different layers of ground formation are, and carefully record the probable depths at which the aquifer begins and ends (the distance that will be screened). Then sketch in the planned length of screen and calculate any distance below the screen to hole bottom and the distance above the screen to surface, adding in the pump depth and allowing for an anticipated drawdown.

7.7 *Check depth and diameter of hole*

However long fluid-drilled holes are pumped clear at the end of drilling they will lose a little depth through settling out of fines at the borehole base. The hole needs to be checked to see that it is properly open and that no clay collars have been left partially blocking the hole or ledges where hard and soft layers have been encountered. While plastic threaded casing can be quite easily removed if it hangs up or does not land at the expected depth, it is often at a day's end this sort of problem arises. Then the drill crew can be easily tempted to push the casing,

perhaps smearing the screen openings closed with clay to the design depth or compromise on the perfect installation depth of the well screen.

One solution to this situation is to build into the drill crew routine the lowering of a weighted dummy length of casing on a rope to check the exact depth of the hole and that the hole will easily pass the dummy from top to bottom without hanging up. If the dummy hangs up on a collar or ledge the recently removed drill pipe can be quickly re-inserted in the hole and the hole reamed to clear the blockage. If the hole has filled up a metre or two and is still open past the aquifer, the final well lining can be designed using the hole bottom as a fixed datum.

A suitable dummy can be easily made up – using a short length of steel pipe the same diameter or perhaps a little bigger than the well-lining diameter with a welded hoop to attach a rope knotted with depth measure marks. Alternatively take a scrap piece of uPVC casing and telescope a smaller length inside, filling the annulus with wet cement grout and fixing in place a suitable bent iron lifting bail (figure 7.1). Try to use a hollow weight as a dummy – a solid weight could act as an effective piston in a soft borehole and pull in the walls when hoisted out of a tightish hole.

7.8 *Preparation of materials*

Measure out your casing and screen components. Do not rely on suppliers quoting/supplying accurate 'dead' lengths: when pipe is either threaded or coupled, actual lengths seem to end up with odd dimensions – remember to calculate an 'effective length' measurement allowing for threading or glue jointing/socketing of the pipe.

Lay out the casing and screen, cleaned and ready for insertion, near the rig in a single pile and keep all other excess material away from it. There is nothing more disconcerting than placing a string of casing and screen in a recently drilled hole, inside a crowd of excited bystanders, to land the casing on what is perceived to be hole bottom and to have the crowd part and a 'helpful' drill crew member march up with one more length of casing to set in motion an agonizing guessing and memory game!



Figure 7.1 *Construction of hollow weighted dummy – ready for filling for weight with cement*

7.9 Forming points on uPVC pipe

It is a good idea to ensure that the foot of the casing or screen inserted into the hole is bevelled or pointed to avoid the risk of slightly bent casing or borehole catching the square lip, making it hard to lower the pipe into the hole.

Most casing manufactures offer some sort of plug or point: some are suitable, others are not. Often they are omitted items from orders.

Perfect points can be formed easily on the drill site using the following method (figure 7.2 & 7.3):

1. Saw 8 triangular points in the casing, using the appropriate dimensions in Table 7. For efficiency, cut a template from a flexible tin sheet to suit the



Figure 7.2 Heating up pipe end to form points

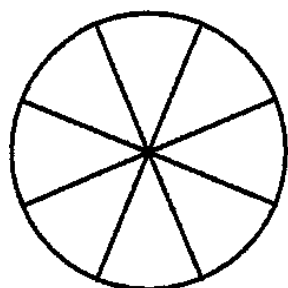

Figure 7.1 Dimensions for Casing Points

Casing Diameter A		B	C	D	E	No of points
mm's	inches (nominal)					
83	2"	25	11.5	198	100	8
90	3"	35	19	283	120	8
113	4"	45	20	355	150	8
168	6"	66	33	528	200	8

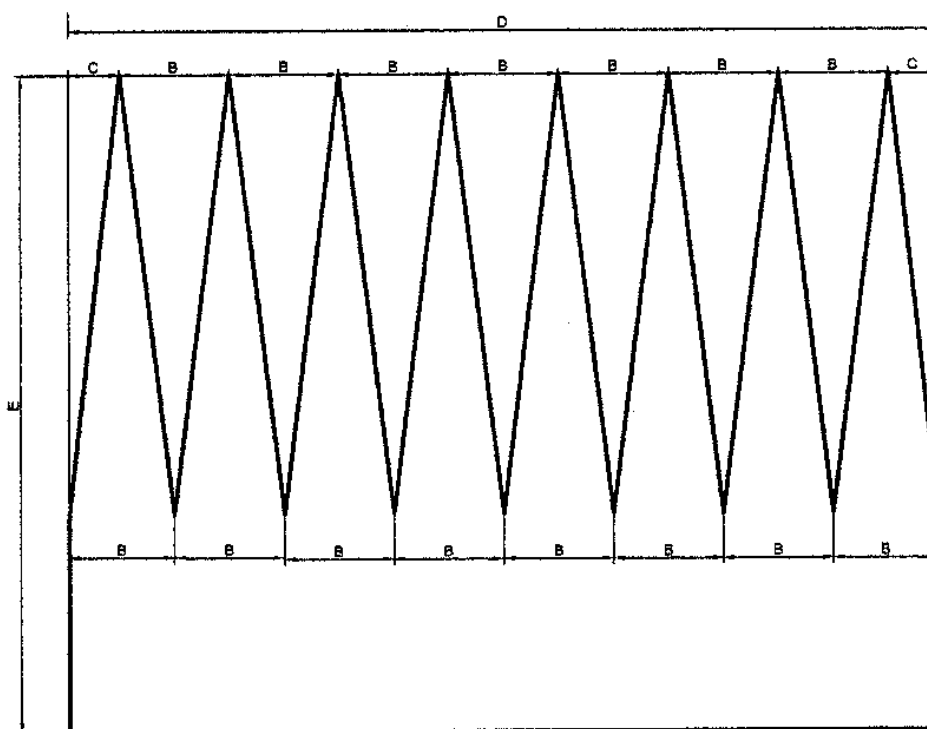
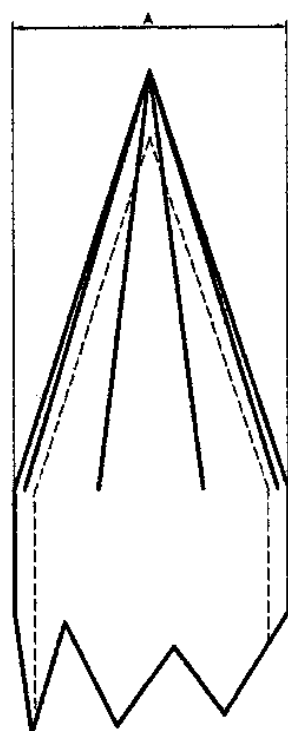

Figure 7.3 Casing points

casing size in common use. This can be wrapped around the casing and the triangles to be cut out can be marked. A hacksaw or wood cutting saw – the finer the cutting teeth the better – can be used to cut uPVC.

2. Heat the sawn end with a 'naked flame' blow torch or over the flames of an open fire until the points become softened.
3. With a gloved hand squeeze the points together, wrapping the formed point with insulating/sticky tape or string. Cool in air or with water to re-harden the heat-softened plastic.
4. This point will have a few gaps – if it is being set into very fine sand or silt the point could be filled internally with 1-2 litres of liquid cement to effect a complete seal.



Figure 7.4 *Threading uPVC casing held securely on rope wraps*

7.10 Lowering uPVC pipe into a drilled hole-flotation effect

A fluid-drilled hole must be kept full of water/ drill fluid to ensure that the ground formation does not collapse. This also has the benefit of supporting the lowered uPVC pipe: uPVC has a specific gravity of 1.4g/mm³ and submersion will reduce the effective weight of the uPVC casing by 70%.

An air-drilled hole might have an appreciable dry length and the casing requires considerably more support during insertion.

7.11 Clamping pipe

A practical method of lowering casing into relatively shallow holes is to use a rope (figure 7.4), with one end anchored to the drilling machine and the other end wrapped three times around the casing/screen pipe and then left loose. Pulling the loose end will prevent slippage into the hole while adding a new length of casing. Threaded casing can generally be hand-tightened, provided the threads are clean, aligned and wetted. Water, clean drill fluid additive or drill foam make good lubricants when threading plastic.

Plastic pipe is seldom straight so threaded casing might require gentle clockwise rotation as it is being lowered to prevent the leading point catching on a ledge in the borehole.

7.12 Completion of boreholes in hard rock

Boreholes in hard rock often require drilling in two stages if a soft formation overlies the hard rock. First a hole should be drilled, with drilling fluid or foam, in the soft formation until contact is made with the hard rock. The diameter of this first hole should be large enough to install the casing. Then drilling into the rock can start, using a down-the-hole hammer and compressed air.

It is important to ensure that the transition from soft to hard rock is properly cased to prevent loose material running into the harder part of the hole un-

der the lip of the casing. It is always good to be able to drill into a soft weathered layer of rock into which to place the casing – this is not always possible where transition from a soft to a hard formation is sudden.

The drilled hole and casing should be measured carefully to ensure that the casing is placed at the correct depth. Having installed the casing, it should be cemented in place both to prevent loose material falling into the rock section of the hole and surface drainage water contaminating ground-water.

Holes in firm rock can be further lined or left unlined. If the rock is hard and relatively strong it is a good idea to leave the hole unlined because this allows water to flow from available fissures without impediment by well screen or introduced sand or gravel pack. Where the rock is soft, and by its nature likely to crumble and collapse, the well should be lined.

7.13 Cementing

There are many different methods of cementing. Below are described Three standard methods.

7.13.1 Displacement

This ensures a good footing for casing. Blank the casing with cement or a drillable plastic plug, and lower it into the hole partially filled with cement-grout. This will displace the cement upwards in the annulus. Careful calculation of the annulus is required to ensure the correct volume of grout is used to fill the required height. The casing centre might need weighting with clean sand to drill out later or alternatively being held down under the drilling rig rotary head until the cement sets.

7.13.2 Foot

Insert the open casing to the hole bottom and then pour a small volume – a few buckets- of cement grout into and around casing and allow to dry (12 hours plus).

7.13.3 Backfilling

If the casing is inserted open ended and landed and embedded into an impermeable clay layer, the total annulus can be back-filled with cement.

Alternatively land the casing then fill the centre with uniform fine building type sand – this will prevent the cement flowing up into the centre of the casing and dry sand can be quickly displaced with air or water after cement has sealed.

In a hole making a transition from a soft to hard formation, it is important to ensure that the entire soft layer is indeed cased off and the base where the casing lands is sealed – loose stones or rocks rolling in can jam pumps – and the casing should be sealed to prevent surface water entering the lower part of the well.

Cement grout is best made up to a specific consistency that will make it liquid – but not so liquid it will crack on setting. A 50-kg bag mixed with 27 litres of water will make 33 litres of cement grout (see various hole volumes, Table 7.1, page 58). Cement takes time to cure: allow a minimum of 12 hours before recommencing any sort of drilling or completion operation. An organised drill crew will anticipate and plan a cementing operation towards the end of a working shift so that cement will harden overnight. Do not use ‘accelerators’ to speed up the setting time because this process works by raising the temperature of the set and this can be high enough to deform uPVC casing.

7.14 Sanitary seal

All holes should at some point of their construction have a cement or bentonite seal to prevent surface water draining into the hole and passing directly into and contaminating the aquifer. The essential and ideal position is to place a seal in a logged depth of impermeable formation; this curtains the aquifer from surface contamination.

Shallow holes with high water table with no impermeable layers should still be sealed but additionally care taken not to introduce contamination by minimising wastewater being spilt on the surface.

7.15 Bentonite pellets

An alternative to cement is to use granulated bentonite, which is a natural clay with enormous swelling properties. The dry granules should be poured into the annulus or hole to be sealed: any

water present will soak into the granules, swelling them so they jam into a tight, impermeable seal.

Having placed the casing and sealed it on to consolidated rock, it should be possible to drill securely with compressed air. It is quite probable that the rock will be solid enough to insert a well pump without requiring any further screen or casing installation.

7.16 Completion of boreholes in unconsolidated formations

Boreholes in unconsolidated formations will require lining with casing and screen: the screen set against potential water-bearing layers and casing in all other areas.

To complete a hole the following procedure should be followed:

7.16.1 Step 1

Remove the drill-pipe, keeping the hole topped up with fluid to prevent collapse of the formation.

7.16.2 Step 2

Plumb the hole to check hole depth and that is clear from obstructions.

7.16.3 Step 3

Maintain hydrostatic head
Select areas for screening carefully measure out the casing and screen, and insert string in hole as described earlier page 40. Continue to keep the hole full of fluid – how many times has this been said!

7.16.4 Step 4

Pump clean water into the casing, sealing the pump hose in the annulus between casing and pump hose temporarily with a cloth or similar material and allow mud/fluid to be displaced from the hole in the annulus between casing and borehole.
Start development of the hole.

7.16.5 Step 5

7.17 Surge block development

Figures 7.5 & 7.6

Use a surge block to force water gently out into the formation beyond the well screen on the down stroke and pull water through the screen on the upstroke. This surging action pulls fines into the well and gently sorts a natural filter bed around the screen.

7.18 Compressed air development

Figures 7.7, 7.8, 7.9, 7.10 & 7.11

To create a surging action, an air compressor can be used to airlift a column of water upwards and then by closing the air valve and venting to atmosphere the built up air pressure in the pipe, will allow the water column to drop downwards into the formation. To create the important surging action properly, it is important to arrange the air inlet pipe work to rapidly bleed off air pressure built up in the air pipe submerged below the water.

7.19 Step 6 Final hole cleaning

Place a small bore pipe and move any accumulation of fine debris at the bottom of the hole to the surface using a water flush or compressed air lift.

7.20 Step 7 Sealing

Backfill the annulus between the casing and the hole with gravel to stabilize the formation to a depth where a cement grout seal can be placed – ideally at a depth of a logged impermeable layer.

7.21 Water level measurement

The water level is best checked with a 'dip tape', which is a simple weighted metal probe that is lowered into a hole on a graduated electric cable. When the probe touches water an electric circuit is made

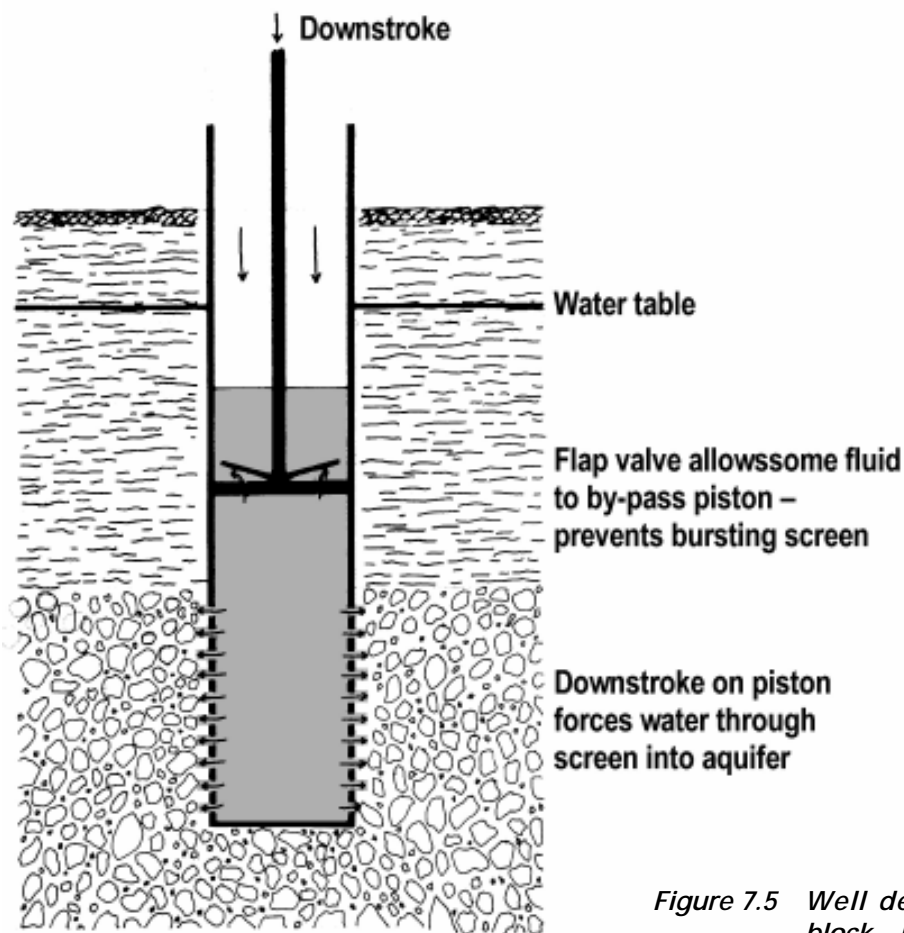

Figure 7.5 Well development with a surge block - Downstroke

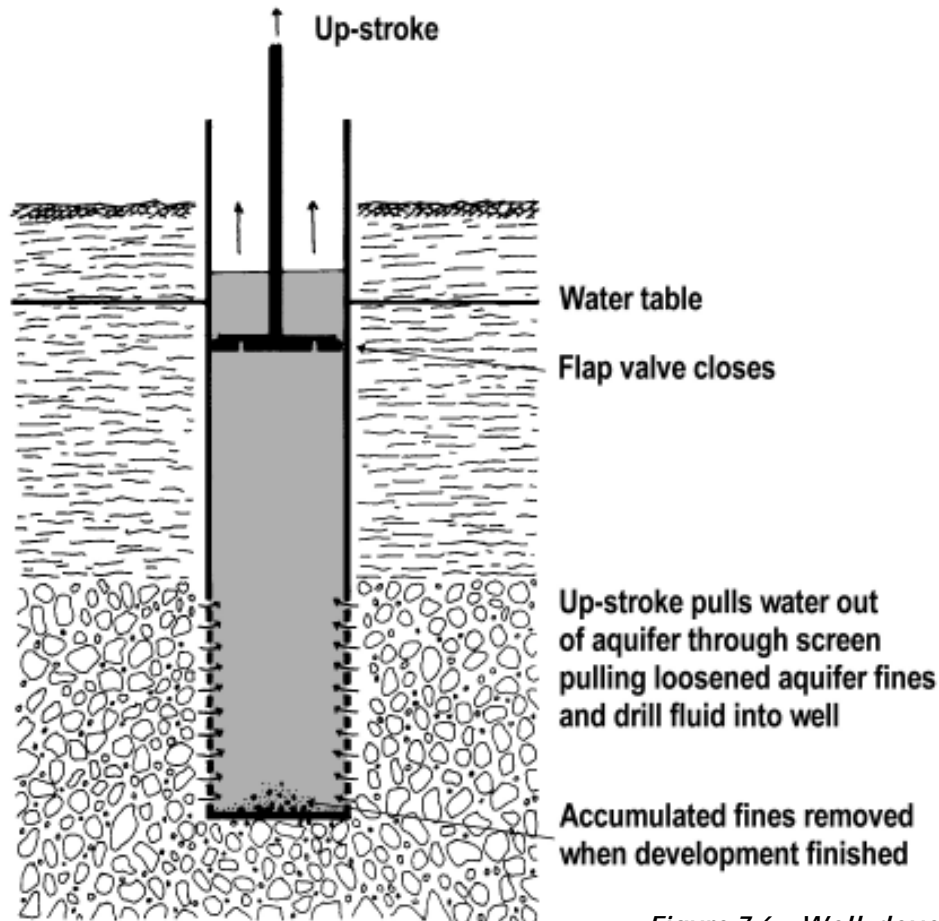

Figure 7.6 Well development with a surge block - Upstroke

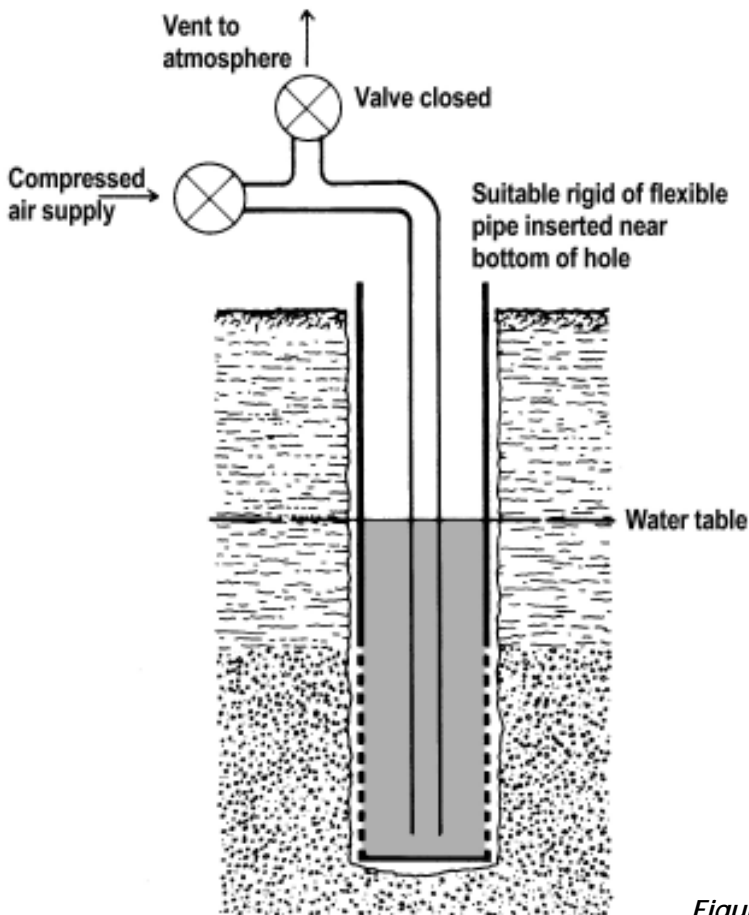

Figure 7.7 Airlift development Step 1

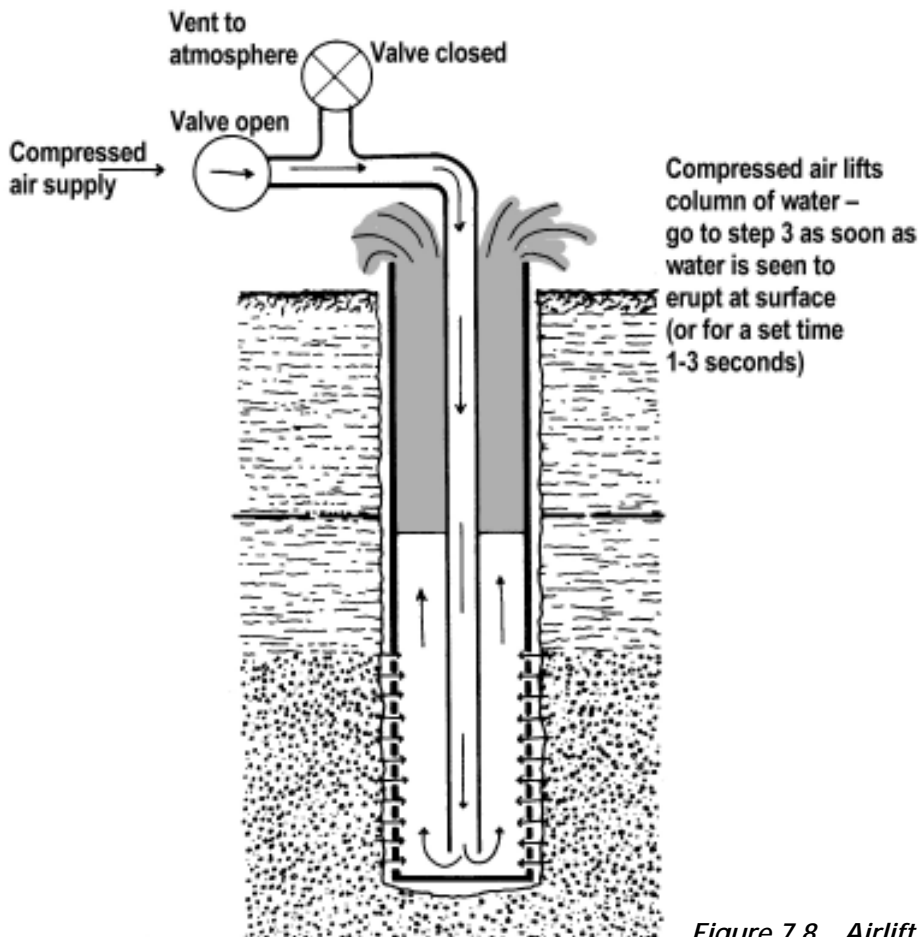

Figure 7.8 Airlift development Step 2

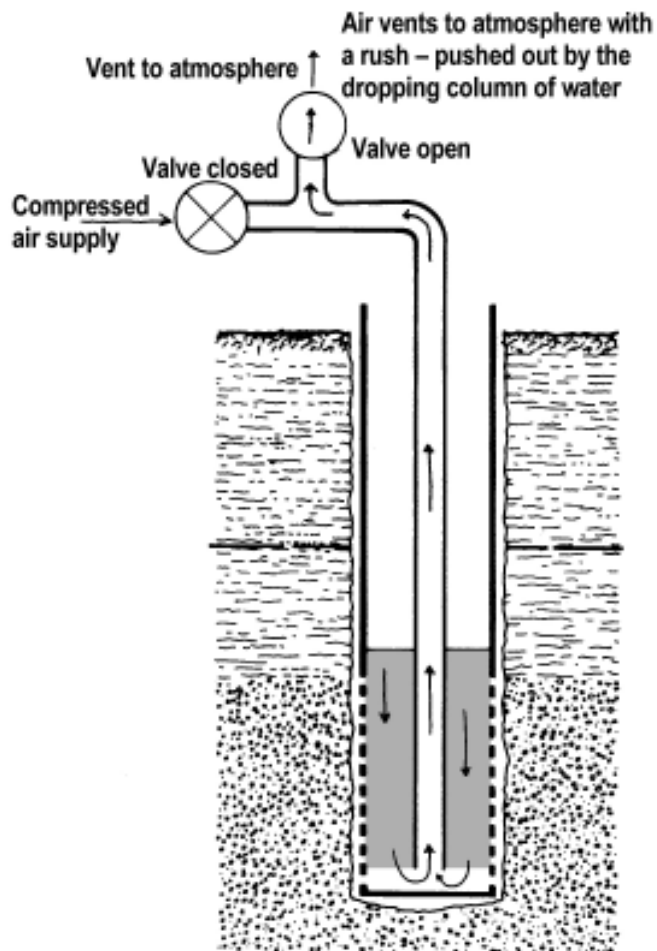

Figure 7.9 Airlift development Step 3

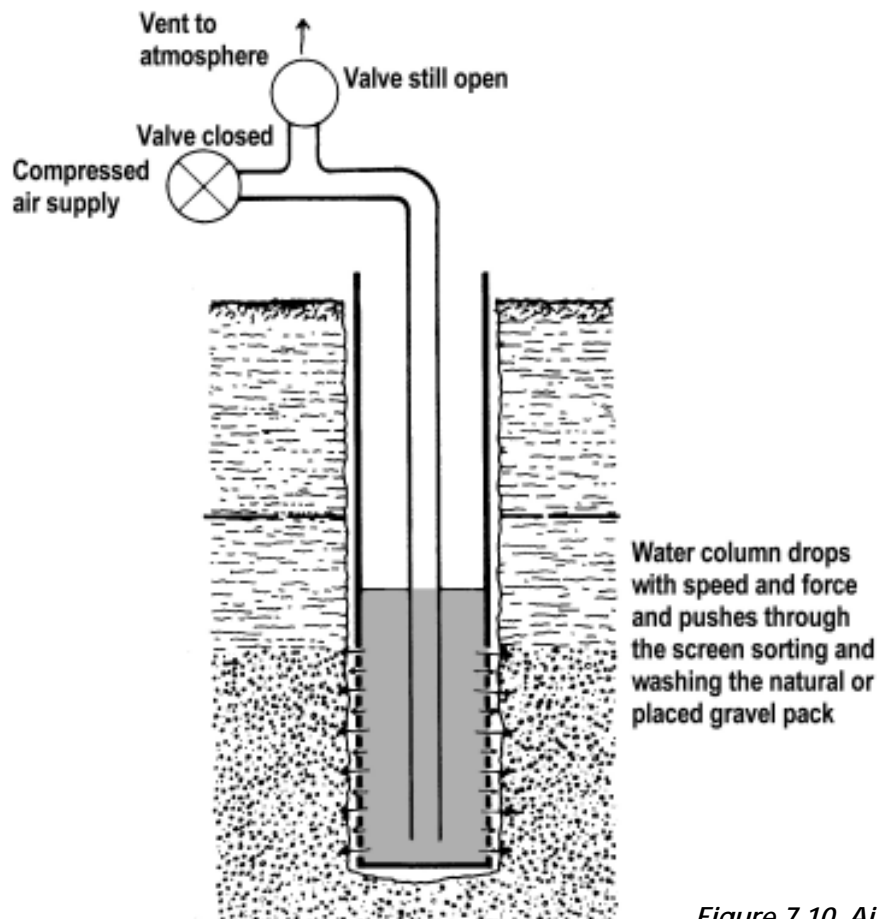

Figure 7.10 Airlift development Step 4



**Figure 7.11 Air development manifold –
Allowing discharge to atmosphere**

between a battery built into the tape drum and a light or buzzer. As water rises or falls in the well it can be measured accurately by lowering or raising the probe in the hole.

The best type of dip tapes is that made from a flat tape with centimetre graduations. It allows both a high degree of accuracy of measurement and also has little tendency to wrap around pipes, unlike a round conventional cable that typically slowly spirals around a pump rising main or drill-pipe when being lowered and then tightens and locks tight when being raised.

Measuring water levels during test pumping is almost impossible to do without a dip tape. Static water level can be measured using spanners or suitable oblong weights tied to string, tape or rope.

7.22 Well monitoring

Accurate recording of water depths is the best way to monitor what is happening to a particular groundwater source. To follow a water table level through a hot dry season into a rainy season and beyond can be the best indicator of how drought-resistant and productive a well is in a particular location. It also allows fine tuning of where screen should be set and how much water can be pumped from a particular aquifer in a typical location.

7.23 Use of gravel pack

Gravel pack placed around the screen and borehole should only be used when an aquifer has an average grain size smaller than the slot size of screen available. With the use of plastic casing, which is available with a good range of fine slots and good open areas, gravel packing should seldom be required.

In many instances, placing gravel pack material between a drilled borehole and screen will effect successful development of the well to maximum water yield because surging will not be able to remove the fines from the borehole walls through the curtaining gravel pack.

Invariably gravel pack seems to be used automatically with all well screen. This is part due to the historic convention arising from drilling techniques and materials based on materials such as large oxy-acetylene cut slots in steel pipe. In addition, to effectively place a cement 'sanitary seal' at the time of drilling, this needs to be set on top of a gravel pack and not allowed to flow and seal off the aquifer. A naturally developed well that effectively gets the formation to collapse on to the screen before placing the 'sanitary seal' might require a few buckets of gravel pack to ensure the screen is effectively covered. Holes passing into rock can usefully deploy a surface casing cemented in and any required screen can be left to naturally develop because the sanitary seal exists between the surface casing and the ground.



**Figure 7.12 Final stages of developing with
compressed air**

7.23.1 *Type of gravel*

Gravel pack should be screened material of a grain size that is consistently just larger than and no more than twice the slot size. Invariably this means that the 'gravel pack' resembles coarse sand rather than typical gravel. The best gravel pack should be hard, washed, well-rounded material, probably obtained from an alluvial source: for example, a dry river bed or lake shore.

If the best local material obtainable is crushed aggregate destined for normal use as concrete aggregate or road chippings, think again about controlling the aquifer. Consider, instead, using an alternative slot size or alternative screen material. Crushed aggregate is sharply angular, is difficult to place and does not function well as a filter.

7.23.2 *Preparation of gravel*

It is best to prepare suitable gravel by grading through maximum/minimum screens and bagging it in set volumes say – 25/30 litres (this will normally equate to about 50kg) – so that exact volumes of use can be calculated easily on site (see Various hole volumes, Table 7.1, page 58).

7.23.3 *Annular space*

In theory, a placed gravel pack has to be only millimetres thick to create a suitable filter between fine aquifer material and screen opening. However, practically, it is a tough job to attempt 360-degree placement of gravel in a small annulus. Established drilling convention is to allow at least 75–100 mm (3–4") thickness of gravel, thus adding 150/200 mm (6/8") to the drilled hole diameter over screen diameter. Shallow holes, drilled cleanly with uPVC lining, might be able to survive under these margins.

It is important to centre the screen in the hole using proprietary winged casing centralisers or a locally devised alternative, such as 20 mm diameter plastic conduit or low pressure pipe wired in a group of three around the screen figure 7.16 – even spiralled to ensure that the screen is held off borehole walls. One of these pipes could be slotted at the screen and continued to the surface to provide a dip tube to monitor both pumped and rest water levels remote from access to the centre of the borehole casing. UPVC casing is con-

siderably more flexible than steel casing and the borehole walls, and will flex naturally in the hole to help achieve an even space for gravel pack placement.

7.23.4 *Gravel placement*

Before starting gravel placement, calculate the exact volume required (Table 7.1). It is reassuring to know that the correct volume of gravel has been poured relative to the length of screen and has not bridged or lodged further up the hole. Be aware that any hole can be eroded larger than drill bit size and it is very common to use more gravel than calculated to achieve placement to a certain depth.

Gravel is best added by trickle-pouring from a sack or bucket into a large funnel with a steady trickle of clean water. The resulting mixture will then flow through a 25–30 mm bore pipe easily, ensuring a controlled rate of flow and preventing bridging between casing and borehole wall (Figure 7.17 & 7.18).

In a fluid-drilled hole that is still full to the surface with water in both the annulus and casing the following effect is often seen – as gravel is evenly and continually poured in to the annulus and drops downwards past the screen, water will be displaced from the annulus through the screen and up the casing to gently overflow the casing lip. As the gravel settles and depth builds up to cover the screen the overflowing will stop abruptly giving a positive indication that the screen is covered with gravel. The key to this effect being seen is that the hole annulus is being completely open and that gravel is being poured consistently and evenly through the funnel at the surface – this requires organising the drill crew and materials to keep up the smooth flow of the gravel (see figure 7.19).

7.23.5 *Do it right or don't bother*

To place a proper gravel pack is a difficult job, requiring a carefully drilled and cased hole and preparation of the correct material. In practice, this is rarely achieved. Usually the driller who is left to his or her own devices with incorrect materials simply shovels the coarsest, most gravel-like material locally obtainable at the borehole annulus and the important graded ring of filter is simply not in place.

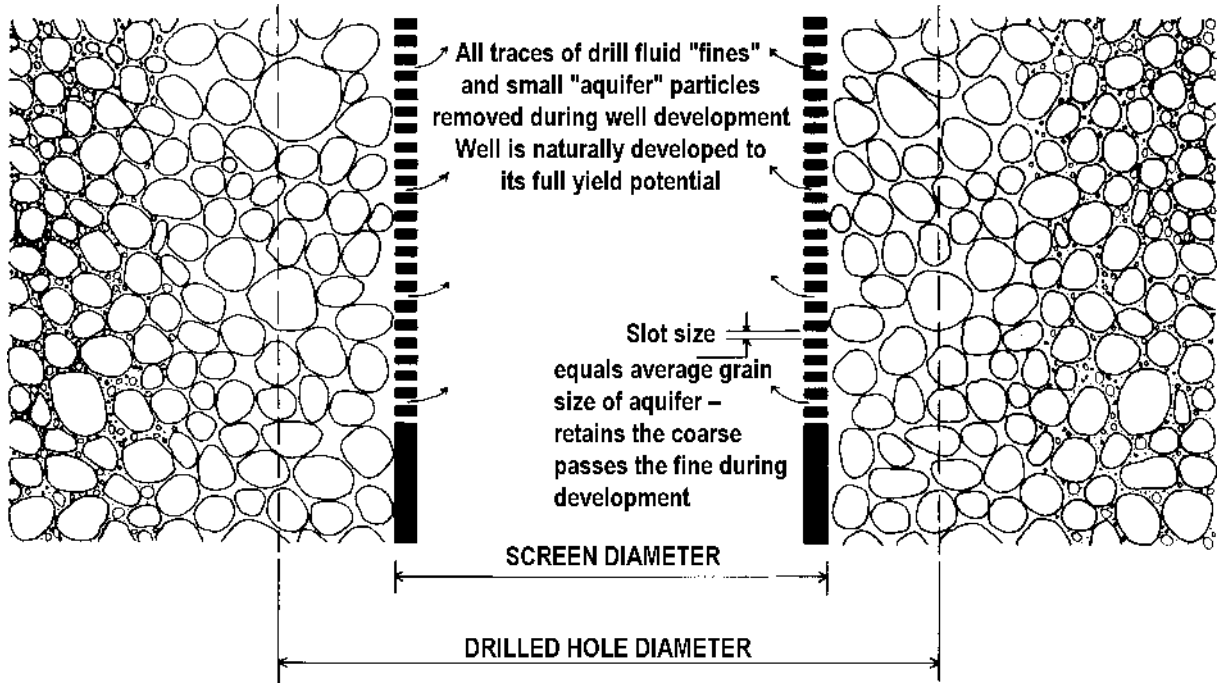

Figure 7.13 Fluid drilled hole naturally developed

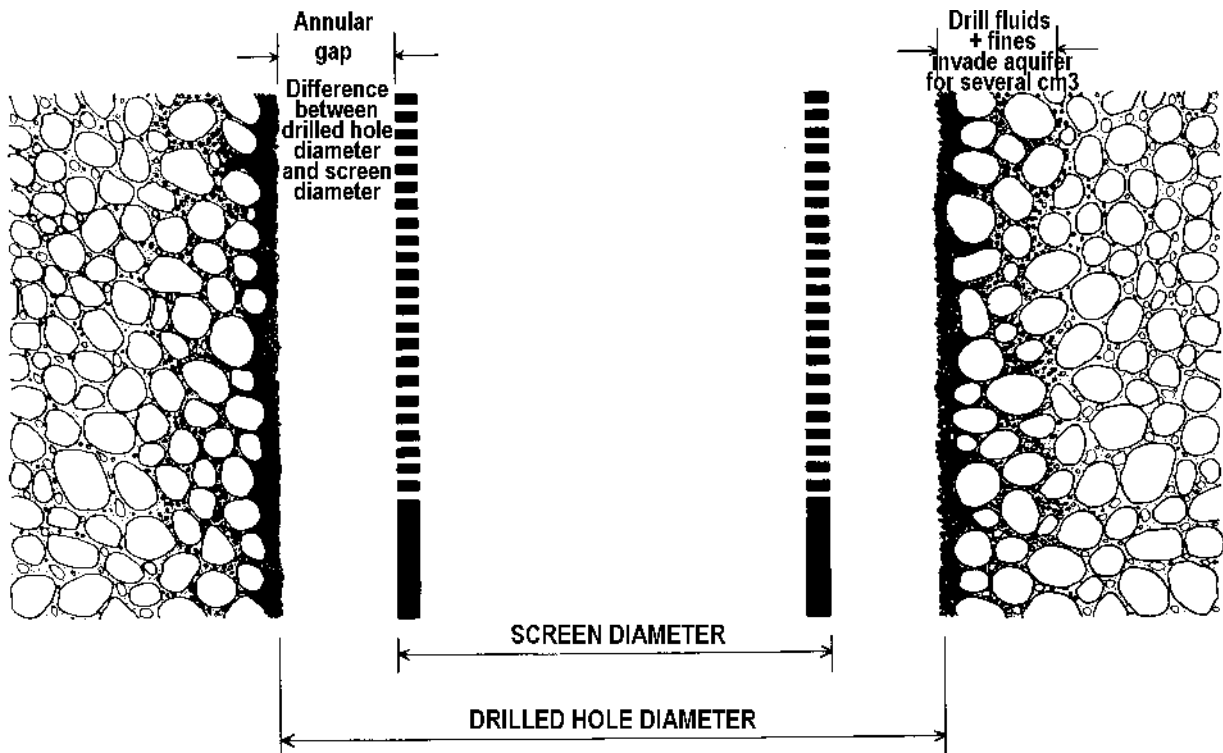

Figure 7.14 Fluid drilled hole before development

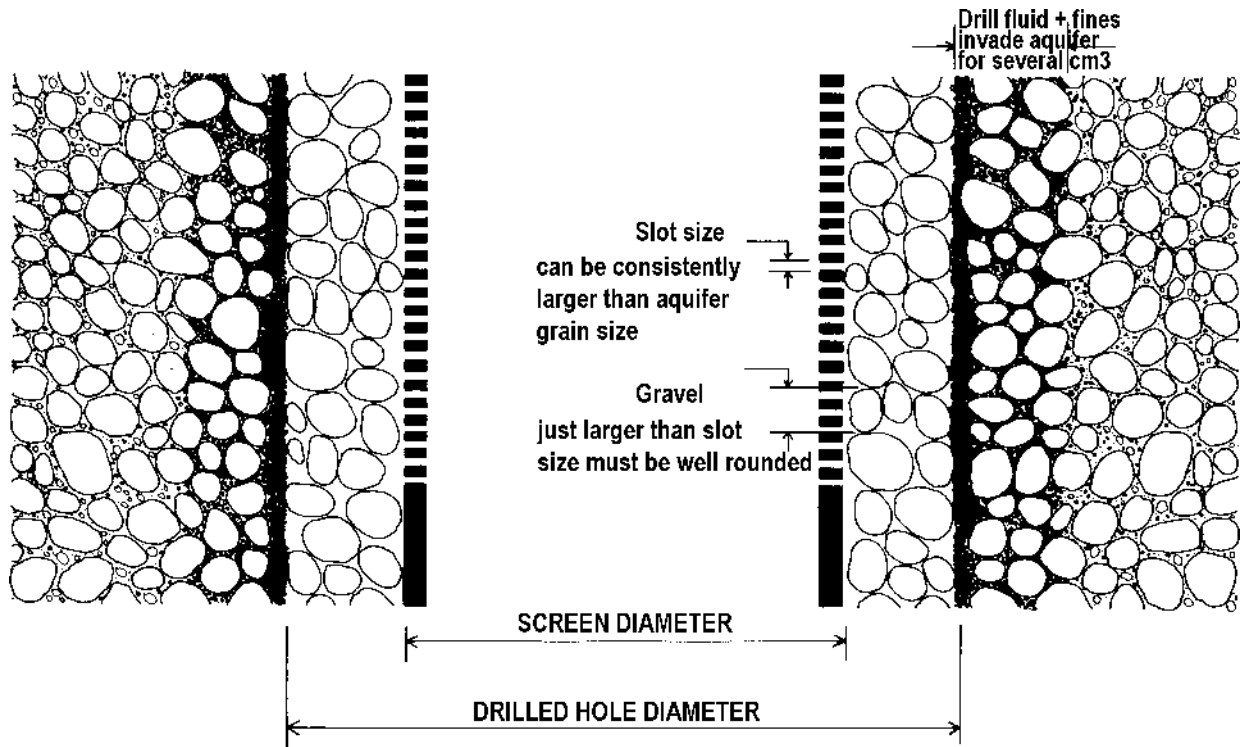

Figure 7.15 Fluid drilled hole with placed gravel pack before development

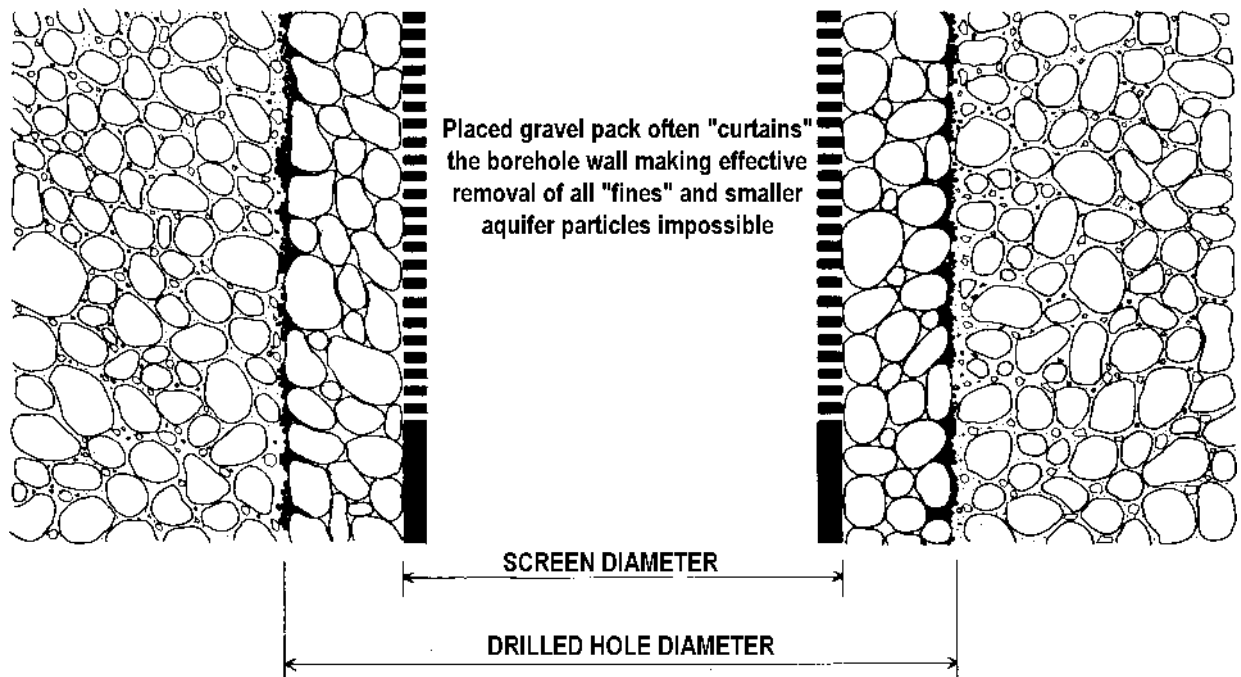

Figure 7.16 Fluid drilled hole packed and developed

Hole Diameter		Depth of Hole - in metres										
mm's	inches			1	1.5	2	3	10	20	30	40	50
50	2"			2	3	4	6	20	39	59	79	98
75	3"			4	7	9	13	44	88	133	177	221
85	3.1/4"			6	9	11	17	57	113	170	227	284
90	3.1/2"			6	10	13	19	64	127	191	254	318
100	4"			8	12	16	24	79	157	236	314	393
115	4.1/2"			10	16	21	31	104	208	312	415	519
125	5"			12	18	25	37	123	245	368	491	614
140	5.1/2"			15	23	31	46	154	308	462	616	770
150	6"			18	27	35	53	177	353	530	707	884
165	6.1/2"			21	32	43	64	214	428	641	855	1,069
200	8"			31	47	63	94	314	628	942	1,257	1,571
250	10"			49	74	98	147	491	982	1,473	1,964	2,454
Annular volume formed between the borehole and a column of pipe inserted inside the hole												
		Pipe Diameter		Depth of Hole - in metres								
		mm's	inches	1	1.5	2	3	10	20	30	40	50
100	4"	48	2"	6	9	12	18	60	121	181	242	302
100	4"	63	2.1/2"	5	7	9	14	47	95	142	189	237
100	4"	75	3"	3	5	7	10	34	69	103	137	172
100	4"	90	3.1/2"	1	2	3	4	15	30	45	60	75
115	4.1/2"	48	2"	9	13	17	26	86	172	257	343	429
115	4.1/2"	63	2.1/2"	7	11	15	22	73	145	218	291	363
115	4.1/2"	75	3"	6	9	12	18	60	119	179	239	298
115	4.1/2"	90	3.1/2"	4	6	8	12	40	81	121	161	201
125	5"	48	2"	10	16	21	31	105	209	314	418	523
125	5"	63	2.1/2"	9	14	18	27	92	183	275	366	458
125	5"	75	3"	8	12	16	24	79	157	236	314	393
125	5"	90	3.1/2"	6	9	12	18	59	118	177	236	296
125	5"	115	4.1/2"	2	3	4	6	19	38	57	75	94
140	5.1/2"	48	2"	14	20	27	41	136	272	408	543	679
140	5.1/2"	63	2.1/2"	12	18	25	37	123	246	368	491	614
140	5.1/2"	75	3"	11	16	22	33	110	220	329	439	549
140	5.1/2"	90	3.1/2"	9	14	18	27	90	181	271	361	452
140	5.1/2"	115	4.1/2"	5	8	10	15	50	100	150	200	250
140	5.1/2"	125	5"	3	5	6	9	31	62	94	125	156
150	6"	48	2"	16	24	32	48	159	317	476	634	793
150	6"	63	2.1/2"	15	22	29	44	146	291	437	582	728
150	6"	75	3"	13	20	27	40	133	265	398	530	663
150	6"	90	3.1/2"	11	17	23	34	113	226	339	452	565
150	6"	115	4.1/2"	7	11	15	22	73	146	219	291	364
150	6"	125	5"	5	8	11	16	54	108	162	216	270
150	6"	140	5.1/2"	2	3	5	7	23	46	68	91	114
165	6.1/2"	48	2"	20	29	39	59	196	391	587	783	979
165	6.1/2"	63	2.1/2"	18	27	37	55	183	365	548	731	913
165	6.1/2"	75	3"	17	25	34	51	170	339	509	679	848
165	6.1/2"	90	3.1/2"	15	23	30	45	150	300	451	601	751
165	6.1/2"	115	4.1/2"	11	16	22	33	110	220	330	440	550
165	6.1/2"	125	5"	9	14	18	27	91	182	273	364	456
165	6.1/2"	140	5.1/2"	6	9	12	18	60	120	180	240	299
200	8"	90	3.1/2"	25	38	50	75	251	501	752	1,002	1,253
200	8"	115	4.1/2"	21	32	42	63	210	421	631	841	1,051
200	8"	125	5"	19	29	38	57	191	383	574	766	957
200	8"	140	5.1/2"	16	24	32	48	160	320	481	641	801
200	8"	165	6.1/2"	10	15	20	30	100	201	301	401	502
250	10"	115	4.1/2"	39	58	77	116	387	774	1,161	1,548	1,935
250	10"	125	5"	37	55	74	110	368	736	1,104	1,473	1,841
250	10"	140	5.1/2"	34	51	67	101	337	674	1,011	1,348	1,685
250	10"	165	6.1/2"	28	42	55	83	277	554	831	1,108	1,385
250	10"	200	8"	18	27	35	53	177	353	530	707	884

Table 7.1 Various hole volumes – in litres

7.24 Rudimentary test pumping

Once a well has been developed free of any accumulated fines, it can be properly evaluated for the amount of water it will yield.

Electric submersible pumps powered by generators make excellent tools for carrying out a basic test pump and where the water table is less than about 6 metres from the surface; a centrifugal suction pump can be used. In both cases the method of deployment is the same (Figure 7.20).

7.24.1 Step 1

Insert the pump so that pump intake/suction is typically 1 metre or more above the screened or water intake portion of the well. Equip the electric submersible pump with a gate valve on the discharge



Figure 7.17 Use of small diameter pipe as centralisers



Figure 7.18 Gravel packing being added by funnel note water overflowing casing – gravel dropping below screened layer

line and have this barely open. A centrifugal suction pump can often be adequately controlled with an engine throttle.

7.24.2 Step 2

Record water rest-level with a dip tape, selecting a convenient datum point, for example, the casing lip. Calculate the maximum drawdown possible before the pump will suck air. Start pumping at initially a minimal rate and constantly monitor the now falling water level in the borehole until the level is stabilised within a few centimetres. Evaluate this with the available drawdown and if significantly distant the gate valve or engine can be opened or increased in speed, increasing pump flow. Once again follow the falling water level with the dip tape, ensuring that the well will remain wet.

It is important to record the water rest-level before or after pumping and the level of drawdown – the level to which the water in the well falls during pumping – and the flow of water being pumped. For general water-well work, the best way of recording flow is to record the time it takes to fill a bucket or receptacle of known volume and calculate a flow per hour, minute or second from that.

7.24.3 Step 3

When most wells are first pumped, they produce cloudy water containing very fine particles. This will clear quite quickly but each time the pumping rate is increased the water will turn cloudy once more. Initial pumping is best done in slow stages: pumping at a steady rate, allowing the water to clear and



Figure 7.19 Gravel packing – note water flow up has stopped – gravel landed above screen level

then stepping up the rate once more. The danger of pumping too much too fast will be to pull a high volume of fine material into the well and this might seize the pump or cause the pump to run dry, at which point it will have to be shut off.

It is good practice to keep a pump running constantly during this cleaning period – constant running is the key to successful transition from a drilled hole to a clean reliable water supply. Initially the volume of water being produced is largely immaterial.

7.24.4 Step 4

Optimum flow can be judged when a stable constant water level is being recorded for a constant flow of clean water. Typically for hand pumps this flow might be fixed at being no more than 1000/1500 litres per hour.

Following this initial test pump set up it would be possible to undertake a more extensive test. This might involve a step test pump – pumping at

various flows and recording draw downs – or a long-term constant volume test, possibly lasting several days. Both of these yield data that reveal important well characteristics to informed experts.

7.25 A basic pump test

One common sense approach to test pumping would be to set the pump to the anticipated flow rate, or perhaps slightly over, of the permanent pump destined for installation in the well and operate it over a similar anticipated cycle of use. For instance, a well destined to be installed with a hand-pump, giving, say, a maximum yield of 1000 to 1500 litres per hour, assuming constant operation, could be pumped by a submersible pump with a 1000–1500 litres per hour capacity for, say 6–8 hours. If the well produces clean water throughout this period while constant water level is recorded, it is an indication that a steady, clean water supply will be available to the hand pump.

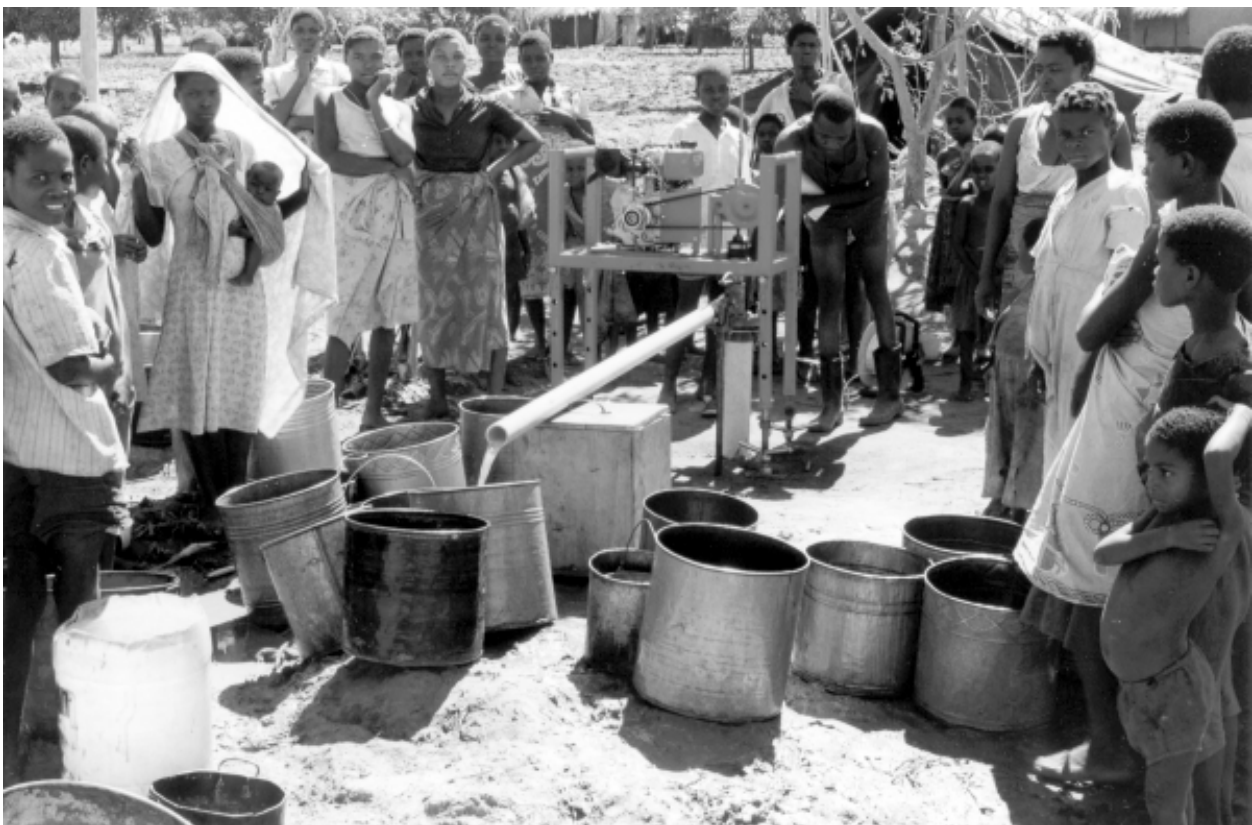

Figure 7.20 Machine test pump – discharged water being disposed of

8. *Use of drilling technology with hand-dug wells*

If water is available under the ground and people need it, they invariably dig for it. This has always been the case worldwide and until tapped, piped water is universally available, people will continue to dig wells by hand. There are many situations where drilling technology and materials can usefully combine with traditional hand-dug well construction.

8.1 *Hand-dug wells have many advantages*

- They can be constructed within a community's own resources;
- They can be technically improved with nominal inputs from outside to line and cap them;
- Water is obtained by a bucket and rope, one of the few completely sustainable water-lifting methods used with ground water;
- By nature of their large diameters they provide valuable storage, which allows exploitation of very small ground-water sources.

8.2 *Disadvantages of hand-dug wells*

- They can be expensive to construct in comparison with a modest drilled well;
- They are able to reach ground-water but are difficult to dig deep into an aquifer to provide a drought-resistant water supply;
- They are a major commitment in labour and community resources;
- To dig deep shafts and fail to reach water is a disappointing set back.

8.3 *Health aspects*

A lot has been written about the relative merits, as far as hygiene is concerned, between an open or capped open dug well and a sealed borehole with a dedicated hand pump. However, in communities

where water distribution, understanding of health and the ability to store water hygienically is rudimentary, surely it makes little difference if contamination takes place in the well, bucket or water storage jar. The answer lies in overall health education rather than in insisting that sealed boreholes are the only answer.

There are uses for modest drilling programmes in conjunction with hand-dug well construction.

8.4 *Prospecting wet sites*

A drilling programme allows a quick feasibility assessment for a community water supply. It is advantageous to have the water supply in the village centre but it may have to be on a geological fault line 500 m away. Drilling rapidly at both the best social and hydrogeological sites can demonstrate the depth to water, the difficulty of digging, the relative volumes available and the relative chemical analyses.

8.5 *Sub-Artesian - confined aquifer*

Where the aquifer is confined by an overlying impervious formation there is an opportunity to combine a drilled hole with a dug shaft. It is possible to construct a small demonstration well by drilling a small diameter hole, say 80 mm, through the confining layer into the water bearing layer. Casing, say 60 mm (2"), and screen, can then be installed, taking care to seal the casing above the screen with cement or bentonite, and the well developed (Figure 8.1).

The water yield can be evaluated with hand bailers or an air compressor yield test, hand pump, or cheap 2" 12 volt submersible pump. A dug shaft can then be sunk around the 2" casing, keeping the pipe

intact, particularly when digging below the water table. Having dug and completed the dry shaft past the water rest-level in the casing without the need for the technically difficult continual de-watering, the casing can then be cut swiftly to allow water to freely flow into the shaft bottom, forming a well.

In the correct hydrogeological conditions, this construction combines the very best of a simple drilled well with a hand dug shaft. The rising pipe gives opportunity to plug off the water supply to clean and disinfect the main shaft. The shaft combines basic bucket and rope removal together with a storage reservoir, which can be important when used with a low-yielding aquifer.

8.6 Hard rock

Confined aquifer conditions are more common than is usually believed – particularly in difficult hard-rock areas where water is located in fissures within the body of the rock at a hit-and-miss range of depths. It is in these situations where 3 metres drilling might take an hour and 3 metres digging might take a lifetime! Most holes drilled into rock will record a water strike at a particular depth to discover later that static water level is often higher up the hole.

8.7 Multiple holes

There are two uses for a small rig in such situations. First, a small-diameter hole can be drilled to look for water as discussed above and then a dug shaft constructed either around or adjacent as local conditions dictate. Second, a drilling operation might be usefully employed in a shaft dug into hard rock but yielding no water, having missed fissures or fractures. Initially a drilled hole can be punched into the bottom of the well to see what is below. Depending on the success of that approach it would be possible to follow up with drilling a series of holes, at slight angles to widen the area of search for potential water-bearing fissures (Figure 8.2).

At best, a dramatic result can be achieved if the drilling strikes a fissure that is confined by the solid rock; the water will flow up the drilled hole into the already dug shaft. A less dramatic result might simply reveal that a further bout of rock breaking will reach the water. At worst, the test drilling will demonstrate that the existing shaft has no purpose and resources can be redirected.

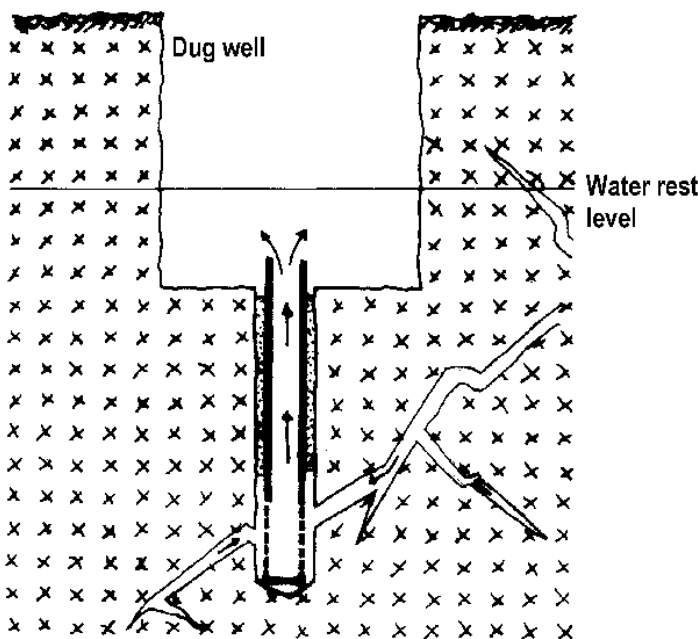

Figure 8.1 Drilled hole either through bottom of existing well or drilled first then a dug shaft sunk around it

8.8 Economy of hole size

This chapter has discussed drilling rock. Earlier chapters revealed that this is best done with down-the-hole hammers powered with air compressors. The key to moderating costs of such exploratory drilling is to restrict the diameter of the hole to an absolute minimum to give you the results required and the ability to test the well. In practical terms, the minimum diameter will be around 50 mm.

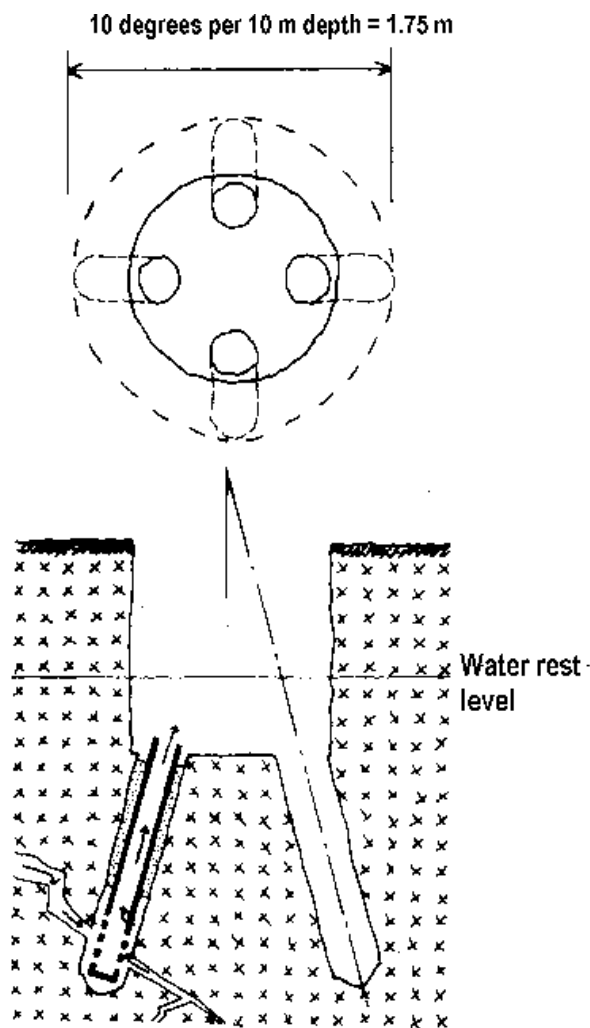

Figure 8.2 Drilled holes "radiating" out to intersect rock fissures

9. *Social responsibilities of the drilling operation*

The water-well driller inherits some responsibilities to his clients when involved in a drilling operation. Water is such a precious commodity to the human race and its free availability has implications, both good and bad, for those who use it.

Increasingly, management involved in providing water supply boreholes is involving communities in the planning and funding of the construction. More time is being taken to address all the implications of providing water: how it is best used; how contamination with harmful bacteria can be avoided; and how waste water can be dealt with without creating fresh health hazards. The well-driller should be involved and contribute to this process.

Before and during getting stuck into the hard physical work of the drilling operation, it is a good idea to talk with the community – the people who are going to benefit from the successful completion of the water supply. Take time to explain the reasons for the site choice, the types of well-lining materials used and the nature of the water supply. This will all lead to the people being directly informed about the nature of their water supply and being in a better position to understand how to use and maintain it. It is often the case that an informed villager can come up with essential detailed information about a borehole many years after written records have been lost or become unavailable.



Figure 9.1 Something gone wrong

Drilled Wells

Most countries have wastefully high numbers of failed or broken wells (Figure 9.1). Most failures of drilled wells result from something relatively insignificant that might easily have been avoided during the construction period. Wells that are not accurately logged under-produce water because the screen is in the wrong position. Pumps break down because insufficient well development was carried out and sand fines wear pump components. (Figure 9.2 & 9.3) Wells that are not properly grouted and back-filled are likely to result in unstable pump foundations. Generally these oversights result from small time- and labour-saving short cuts taken by the drill crew.

One management tool to promote better quality is to connect the drill crew to the overall construction goal of provision of a clean, dependable water source rather than the efficient operation of a drilling machine. Like a deal of technology, emphasis is drawn to the expensive technology and how it works and not the work it actually does. Very little about a good groundwater source is about how the drilling technology works; it is mostly reliant on what and how permanent materials are used to enable clean water to be pumped.



Figure 9.2 Borehole inadequately developed and left for user to sort out



Figure 9.3 Borehole properly developed and sealed ready for handover to user

10. *When things go wrong*

There is a dark side to working with drilling equipment and constructing water supply holes. Numerous projects can be sited worldwide where huge amounts of resources have been swallowed up by 'drilling programme's for seemingly little construction impact. It is essential to select the right equipment for all the aspects of the operation – the correct sized and powered rig complemented by a borehole design that minimises diameters and leads to selection of drill bit sizes and to mud pump and compressor selection.

When things go wrong, situations often develop from bad to worse very quickly. The driller and his crew are at some remote location with little opportunity of getting technical assistance in the form of people or equipment to get them out of trouble. Most chapters of this manual have been positive and written with all the goals of good theory and good practice based on years of opportunity and hindsight. This chapter deals with things when they have gone wrong.

10.1 *Stuck drill pipe*

The drill pipe does not rotate freely and it is impossible to raise or lower it in the hole.

First the obvious, for drill pipe to get stuck something must have been fundamentally wrong with the drilling method in the geology being drilled. Insufficient hole cleaning capacity with air or fluid – what was it that went wrong and why? Try and avoid whatever it was in the future.

It is commonsense for a driller to expect that for each metre he drills into the ground he should expect to see at the surface an equivalent volumetric amount of spoil at the surface – they should worry if no spoil is being transported and indeed if too much is being delivered to the surface. In the latter case a cavern may be being created into which the hole might slump and take the rig in with it!

10.1.1 *By and large these are the steps to follow*

Step 1

Regain circulation through the drill pipe and up the hole whether it be air, fluid or foam or even maybe introducing one or other new to the hole. If using air flush in soft ground that has partially collapsed or fragments of rock have jammed between the borehole walls and drill pipe, introduce foam. This can be very basic addition of a bucketful of soapy water down the centre of the drill pipe or even the borehole annulus if a foam pump is not plumbed in. The foam will help lift clear large particles and will lubricate and dilute debris at the hole bottom. The action of breaking a drill pipe connection and letting the backed-up air or fluid pressure escape can allow a pressure surge to develop when drill pipe is re-connected to break through the blockage. If using fluid try and increase both or either the viscosity and pumping rate of the fluid – if using centrifugal pumps it can be possible to couple a pair of pumps inline – pushing the delivery of one pump into the suction port of a second – this will double the pressure head and might clear the blockage.

Step 2

Preferably in conjunction with Step 1 – regain the rotation. Use the machine power to try and jerk the drill pipe into constant rotation, perhaps simultaneously with a small up or down movement to attempt to release the drill pipe. On light- powered equipment it might be necessary to put a strong wrench and use a lever to induce the drill pipe into rotation manually. Resist the temptation to try reverse-rotating the drill pipe because you will not be sure if you are simply unthreading a pipe joint.

Step 3

Having regained both circulation and rotation patiently raise the drill pipe – back drilling until the drill

bit is completely free once more. Sometimes a drill bit can be raised by only millimetres a minute – but all movement is good and patience is required.

Step 4

Only proceed back down the hole after the original fault that caused the drill pipe to jam has been corrected and the drilling operation adjusted for.

What rarely works is pure force by hoisting the drill pipe upwards by using powerful jacks or a crane – this normally wedges the jammed pipe even tighter until it breaks.

10.2 Fishing

This is the descriptive term given to retrieving anything that has fallen down a borehole, one hopes by accident.

The very first step is to give sufficient space to think clearly and not make things worse by pre-emptive action of the wrong sort. Determine exactly what has been dropped, where it has landed, and what devices will first couple with it if lowered and then be strong enough to hold on to it while it be lifted. If you have the wrong device to catch the dropped item take time to adapt or make a device that will catch hold securely. A few ideas help at this stage to refine a device to get the desired result.

10.2.1 Magnet

A magnet on a rope can retrieve odd bits of steel or a spanner inadvertently dropped into a hole. A good drill crew get into the habit of always covering an open hole with a bucket, spade or plank whenever it is left open to prevent anything inadvertently dropping down.

10.2.2 Threaded pipes

A threaded pipe can be retrieved by the corresponding threaded end – if a pipe has damaged threads or a broken coupling it can be retrieved by a special 'tap' or 'overshot' – these are made from carbon steel and hardened with fine tapered threads to match inside for the 'tap' or to the outside of a tube in case of an 'overshot' – these have to be available in advance because there is little chance of rustling up manufacture of these in small machine shops.

In all these cases the method of fishing is the same. Dip the hole with a dipper or a weight on a measuring tape and chalk up a string of drill pipe showing the depth the fish will be made. Insert the fishing thread or tool into the hole and try and make a connection by jiggling the pipe up and down. Mark the pipe with a bit of chalk adjacent to the rig table or something similar – with maybe another mark 50 mm above. Thread the pipe up by hand – with luck you might feel the threads making up – becoming tighter- and, importantly, the chalk marks dropping, showing the threads are indeed steadily coupling together. If the chalk mark does not move downwards pick and re-jiggle to try and make the connection align. Once the connection has been made lift out the pipe – take care to be gentle with the pipe handling as the 'fish' might only be lightly caught and or cross threaded and a sudden jar might get it to drop off again.

Plastic pipe can be retrieved by a steel spear with sharp angle barbs or spikes that will spring into the inside of the pipe and dig in and bite into the bore when raised.

Galvanised pipe (pump rising main) with couplings can be retrieved by sliding larger diameter steel pipe over the fish with some internal strips cut and bent inwards as barbs. These can be pushed or sprung over a coupling and then the fish hoisted upwards.

10.3 Borehole cameras

Inexpensive borehole cameras are available that can give a quick view of what is below ground, an invaluable 'eye in the ground' (Figures 10.1 & 10.2).

Camera systems can be very sophisticated with motorised winches and with automatic depth – recording, allowing detailed analysis of a borehole top to bottom – a simpler camera held by hand on a cable or tape can quickly be lowered to give the essential view of a problem or to seek information.

In a regular drilling operation cameras can quickly determine the competence of landing and cementing casing where a hole has been drilled through set casing into firm rock – they will positively confirm the fissures drilled through and the occurrence of further underlying fissures. It is easy to spot the first major water strike in a rock hole drilled with com-

pressed air but subsequent strikes can be harder to spot and quantify. A quick camera run will allow each fissure passed to be examined and the depth measured.

In any sort of rehabilitation of an old well a camera is an invaluable tool it can simply check out the well construction, double check any existing borehole log to ensure whether well screen is set at the correct depth and is in working condition. Any sort of damage, dropped pumps or parted casing can be seen on screen and assessed for possible fishing or repair.

With initiative, cameras can be used to show a lot more – for instance, inserted below a submersible test pump with neutral weighted streamers – polythene bag strips - they can be used to visualise and work out which fissures are yielding the water flow.



Figure 10.1 Borehole camera

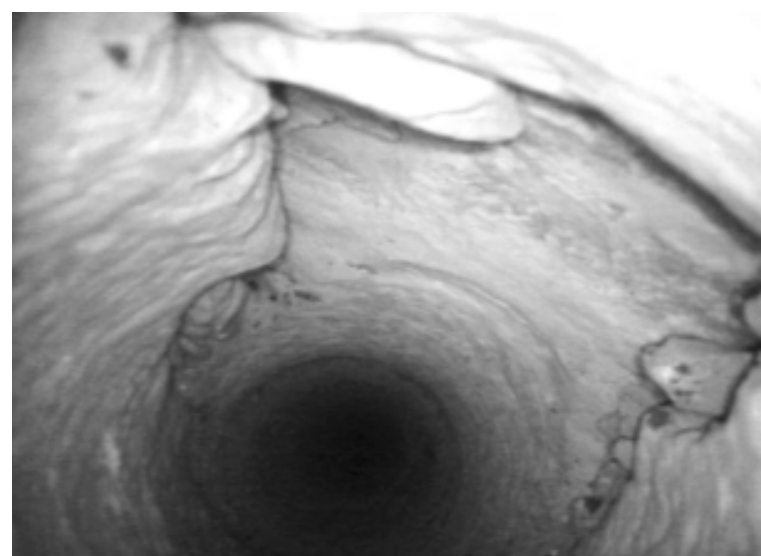

Figure 10.2 Camera shot of rock hole

Index

A

Air compressor 19
Air Pressure 21
Air volume 19

B

Barrel Type Pump 29
Bent holes 4
Borehole cameras 68
Borehole design 35
Borehole diameter 19
Borehole log 32

C

Catchment area 39
'chalk' the drill-pipe 31
Compressed air 19
Conductor casing 21

D

Difficult drilling – 'boulders' 25
Direct acting 36
Down-the-hole hammer 3, 19, 22
Drag blade 3, 22
Drill collars 4
Drill pipes 4
Drilling with compressed air 31
Dummy 46

E

Economy of hole size 63
Electric Submersible pumps 36

F

Fishing 68
Fluid drilled holes 31
Foam 27
Foam inlet manifold 29
Foam pump types 28
Fractured rock 40

G

Galvanised pipe (pump rising main) 68
Geotextile 43

H

Hammer Maintenance 23
Hammer stripping 24
Hand Pump 29
Hand pumps 35
Hand-dug wells 61
Hard rock 62
Health aspects 61
High velocity foam – air misting 27
Hole stability 21, 27
Hydrogeologists 40
Hydrogeology 39

K

'kinetic' energy 24

L

Latrines 41
Levered 36
Logging of samples 31
Low velocity foam – stable foam column 27
Lubrication 23

M

Magnet 68
Multiple holes 62

N

Non return valve 23
Non- return valve sub adapter 28

P

Perpendicular 4
Piston Pumps 29
Polyester stocking 43
Porous rock 39

R

Reverse-circulation hammers 26
Rotation speed 23

S

Sample collection 32
Sedimentary deposits 39
Shock absorbers 24
Spindle-driven pumps 36
Stabiliser 4
Steel spear 68
Stuck drill pipe 67
Sub-Artesian - confined aquifer 61
Suction pumps 38
Sustainability 35

T

Telescopic casing & screen 43
Threaded pipes 68

U

uPVC pipe 41

V

'valved' 22
'valveless' 22

W

Water strikes 31
Well casing 41
Well dippers 28
Well screen 41
Well-lining materials 41
Well-rehabilitation 32

SERIES OF MANUALS ON DRINKING WATER SUPPLY

VOLUME	1	Management Guide
VOLUME	2	Engineering
VOLUME	3	Building Construction
VOLUME	4	Spring Catchment
VOLUME	5	Hand-dug Shallow Wells
VOLUME	6	Drilled Wells
VOLUME	7	Water Lifting

What you should know about this series of manuals:

It is a guide for	project managers, engineers and technicians
	but is also useful for all other actors in the sector
with a focus on	community based managed systems (predominantly in rural areas)
	water supply
	technologies
with an emphasis on	a balanced strategy including technical, social, institutional, economic and regulatory aspects for the achievement of sustainability
providing options for	management
	strategies and approaches
providing linkages to	sanitation and health
limited to	experience in Swiss-supported projects, taking account of new developments
does not cover	sanitation
	drainage
	solid waste management
Volumes 2 to 7	should be used in conjunction with Volume 1

ISBN

3-908001-98-6